

# ProSim™ 4

Vital Signs Simulator

## Users Manual

### **Warranty and Product Support**

Fluke Biomedical warrants this instrument against defects in materials and workmanship for one year from the date of original purchase OR two years if at the end of your first year you send the instrument to a Fluke Biomedical service center for calibration. You will be charged our customary fee for such calibration. During the warranty period, we will repair or at our option replace, at no charge, a product that proves to be defective, provided you return the product, shipping prepaid, to Fluke Biomedical. This warranty covers the original purchaser only and is not transferable. The warranty does not apply if the product has been damaged by accident or misuse or has been serviced or modified by anyone other than an authorized Fluke Biomedical service facility. NO OTHER WARRANTIES, SUCH AS FITNESS FOR A PARTICULAR PURPOSE, ARE EXPRESSED OR IMPLIED. FLUKE SHALL NOT BE LIABLE FOR ANY SPECIAL, INDIRECT, INCIDENTAL OR CONSEQUENTIAL DAMAGES OR LOSSES, INCLUDING LOSS OF DATA, ARISING FROM ANY CAUSE OR THEORY.

This warranty covers only serialized products and their accessory items that bear a distinct serial number tag. Recalibration of instruments is not covered under the warranty.

This warranty gives you specific legal rights and you may also have other rights that vary in different jurisdictions. Since some jurisdictions do not allow the exclusion or limitation of an implied warranty or of incidental or consequential damages, this limitation of liability may not apply to you. If any provision of this warranty is held invalid or unenforceable by a court or other decision-maker of competent jurisdiction, such holding will not affect the validity or enforceability of any other provision.

7/07

## Notices

---

### All Rights Reserved

© Copyright 2015, Fluke Biomedical. No part of this publication may be reproduced, transmitted, transcribed, stored in a retrieval system, or translated into any language without the written permission of Fluke Biomedical.

---

### Copyright Release

Fluke Biomedical agrees to a limited copyright release that allows you to reproduce manuals and other printed materials for use in service training programs and other technical publications. If you would like other reproductions or distributions, submit a written request to Fluke Biomedical.

---

### Unpacking and Inspection

Follow standard receiving practices upon receipt of the instrument. Check the shipping carton for damage. If damage is found, stop unpacking the instrument. Notify the carrier and ask for an agent to be present while the instrument is unpacked. There are no special unpacking instructions, but be careful not to damage the instrument when unpacking it. Inspect the instrument for physical damage such as bent or broken parts, dents, or scratches.

---

### Technical Support

For application support or answers to technical questions, either email [techservices@flukebiomedical.com](mailto:techservices@flukebiomedical.com) or call 1-800-850-4608 or 1-440-248-9300. In Europe, email [techsupport.emea@flukebiomedical.com](mailto:techsupport.emea@flukebiomedical.com) or call +31-40-2965314.

---

### Claims

Our routine method of shipment is via common carrier, FOB origin. Upon delivery, if physical damage is found, retain all packing materials in their original condition and contact the carrier immediately to file a claim. If the instrument is delivered in good physical condition but does not operate within specifications, or if there are any other problems not caused by shipping damage, please contact Fluke Biomedical or your local sales representative.

---

### Returns and Repairs

#### Return Procedure

All items being returned (including all warranty-claim shipments) must be sent freight-prepaid to our factory location. When you return an instrument to Fluke Biomedical, we recommend using United Parcel Service, Federal Express, or Air Parcel Post. We also recommend that you insure your shipment for its actual replacement cost. Fluke Biomedical will not be responsible for lost shipments or instruments that are received in damaged condition due to improper packaging or handling.

Use the original carton and packaging material for shipment. If they are not available, we recommend the following guide for repackaging:

- Use a double-walled carton of sufficient strength for the weight being shipped.
- Use heavy paper or cardboard to protect all instrument surfaces. Use nonabrasive material around all projecting parts.
- Use at least four inches of tightly packed, industry-approved, shock-absorbent material around the instrument.

#### Returns for partial refund/credit:

Every product returned for refund/credit must be accompanied by a Return Material Authorization (RMA) number, obtained from our Order Entry Group at 1-440-498-2560.

#### Repair and calibration:

To find the nearest service center, go to [www.flukebiomedical.com/service](http://www.flukebiomedical.com/service) or

##### In the U.S.A.:

Cleveland Calibration Lab  
Tel: 1-800-850-4608 x2564  
Email: [globalcal@flukebiomedical.com](mailto:globalcal@flukebiomedical.com)

Everett Calibration Lab  
Tel: 1-888-99 FLUKE (1-888-993-5853)  
Email: [service.status@fluke.com](mailto:service.status@fluke.com)

##### In Europe, Middle East, and Africa:

Eindhoven Calibration Lab  
Tel: +31-40-2675300  
Email: [ServiceDesk@fluke.com](mailto:ServiceDesk@fluke.com)

##### In Asia:

Everett Calibration Lab  
Tel: +425-446-6945  
Email: [service.international@fluke.com](mailto:service.international@fluke.com)

To ensure the accuracy of the Product is maintained at a high level, Fluke Biomedical recommends the product be calibrated at least once every 12 months. Calibration must be done by qualified personnel. Contact your local Fluke Biomedical representative for calibration.

---

## Certification

This instrument was thoroughly tested and inspected. It was found to meet Fluke Biomedical's manufacturing specifications when it was shipped from the factory. Calibration measurements are traceable to the National Institute of Standards and Technology (NIST). Devices for which there are no NIST calibration standards are measured against in-house performance standards using accepted test procedures.

---

## WARNING

Unauthorized user modifications or application beyond the published specifications may result in electrical shock hazards or improper operation. Fluke Biomedical will not be responsible for any injuries sustained due to unauthorized equipment modifications.

---

## Restrictions and Liabilities

Information in this document is subject to change and does not represent a commitment by Fluke Biomedical. Changes made to the information in this document will be incorporated in new editions of the publication. No responsibility is assumed by Fluke Biomedical for the use or reliability of software or equipment that is not supplied by Fluke Biomedical, or by its affiliated dealers.

---

## Manufacturing Location

The ProSim™ 4 is manufactured at Fluke Biomedical, 6920 Seaway Blvd., Everett, WA, U.S.A.

# Table of Contents

Title	Page
Introduction.....	1
Intended Use .....	1
Safety Information .....	2
Symbols.....	3
Unpack the Product.....	3
Accessories .....	4
Instrument Familiarization .....	5
How to Turn On the Product.....	7
ECG Simulation .....	8
Arrhythmia Simulation .....	10
How to Set an Arrhythmia ECG Waveform .....	11
How to Output a Performance Wave.....	11
Respiration Simulation .....	11
Non-Invasive Blood Pressure Simulation and Tests .....	12
How to Set the Non-Invasive Blood Pressure Parameters.....	12
How to Do an NIBP Monitor Test .....	14
How to Do a Pressure Relief Test .....	14
How to Do a Leak Test.....	15
How to Check a Manometer .....	17
Invasive Blood Pressure Simulation .....	18
Autosequences.....	19
Setup Features .....	22
How to Set the Backlight Intensity Level .....	22
How to Change the Language for the Display.....	23
How to Show Instrument Information in the Display.....	24
Maintenance .....	24
How to Clean the Product.....	25
Battery Maintenance.....	25
How to Charge the Battery .....	26
Battery Removal .....	27
General Specifications .....	27
Detailed Specifications .....	28
Normal-Sinus-Rhythm Waveform.....	28
Arrhythmia .....	28
ECG-Performance-Testing.....	29
Respiration .....	29

Invasive Blood Pressure.....	29
Non-Invasive Blood Pressure.....	29
Presets and Autosequences.....	30
<b>Glossary .....</b>	<b>A-1</b>

# ***List of Tables***

<b>Table</b>	<b>Title</b>	<b>Page</b>
1.	Simulation Types.....	1
2.	Symbols.....	3
3.	Standard Accessories .....	4
4.	Optional Accessories.....	4
5.	Product Controls and Connections.....	5
6.	Display Features .....	6
7.	Pre-Defined Patient Simulations .....	8
8.	ECG Lead Amplitudes .....	10
9.	Autosequences.....	21





# *List of Figures*

<b>Figure</b>	<b>Title</b>	<b>Page</b>
1.	Home Screen .....	7
2.	ECG Connections.....	9
3.	ECG Screen .....	9
4.	Arrhythmia Screens.....	10
5.	Respiration Screen.....	11
6.	Non-Invasive Blood Pressure Test Connections.....	12
7.	Blood Pressure Cuff Mandrel Sizes .....	13
8.	Non-Invasive Blood Pressure Screen .....	14
9.	Pressure Relief Test Screen .....	15
10.	Leak Test Screen .....	16
11.	Leak Test Results Screen .....	17
12.	Manometer Check Connections .....	17
13.	Invasive Blood Pressure Connections.....	18
14.	Invasive Blood Pressure Screen .....	18
15.	Static Pressure Screen.....	19
16.	Monitor Testing Autosequence Screen .....	19
17.	Monitor Testing Autosequence Steps Screen .....	20
18.	Setup Screen.....	22
19.	Backlight Screen .....	22
20.	Language Screen .....	23
21.	Instrument Information Screen .....	24
22.	External Battery Charging Connections .....	26
23.	Battery Removal.....	27



## **Introduction**

The ProSim™ 4 Vital Signs Simulator (the Product) is a portable vital signs monitor functional tester.

The product simulates:

- ECG Functions
- Respiration
- Invasive and non-invasive Blood Pressure

When the term simulation is used in connection with ECG, respiration, IBP, or NIBP, the simulation type shown in Table 1 is used in this Product.

**Table 1. Simulation Types**

<b>Parameter</b>	<b>Simulation Type</b>
ECG	Electrical
Respiration	Electrical
IBP	Electrical
NIBP	Pneumatic

## **Intended Use**

The Product is intended to be used to test and verify the basic operation of patient monitoring devices or systems used to monitor various physiological parameters of a patient, including ECG, respiration, invasive blood pressure, and non-invasive blood pressure.

The intended user is a trained biomedical equipment technician who performs periodic preventative maintenance checks on patient monitors in service. Users can be associated with Hospitals, clinics, original equipment manufacturers and independent service companies that repair and service medical equipment. The end user is an individual, trained in medical instrumentation technology.

This Product is intended to be used in the laboratory environment and is not intended for use on patients, or to test devices while connected to patients. This Product is not intended to be used to calibrate medical equipment. It is intended for over the counter use.

## Safety Information

In this manual, a **Warning** identifies hazardous conditions and actions that could cause bodily harm or death. A **Caution** identifies conditions and actions that could damage the Analyzer, the equipment under test, or cause permanent loss of data.

### Warnings

To prevent personal injury, use the Product only as specified, or the protection supplied by the Product can be compromised.









To prevent possible electrical shock, fire, or personal injury:

- Do not use and disable the Product if it is damaged.
- The battery door must be closed and locked before you operate the Product.
- Remove all probes, test leads, and accessories that are not necessary for the measurement.
- Do not use the Product around explosive gas, vapor, or in damp or wet environments.
- Do not use the Product if it operates incorrectly.
- Do not connect the Product to a patient or equipment connected to a patient. The Product is intended for equipment evaluation only and should never be used in diagnostics, treatment, or any other capacity where the Product would come in contact with a patient.
- Read all safety Information before you use the Product.
- Examine the case before you use the Product. Look for cracks or missing plastic. Carefully look at the insulation around the terminals.
- Carefully read all instructions.

## Symbols

Table 2 is a list of symbols found in this manual or on this Product.

Table 2. Symbols

Symbol	Description	Symbol	Description
	Risk of danger. Important information. See manual.		Hazardous voltage. Risk of electric shock.
	Conforms to European Union directives.		Input jack for the DC output of the AC/DC supply connector.
	Conforms to relevant Australian EMC standards		Conforms to relevant North American Safety Standards.
	Spent Lithium batteries should be disposed of by a qualified recycler or hazardous materials handler per local regulations. Contact your authorized Fluke Service Center for recycling information.		
	This product complies with the WEEE Directive (2002/96/EC) marking requirements. The affixed label indicates that you must not discard this electrical/electronic product in domestic household waste. Product Category: With reference to the equipment types in the WEEE Directive Annex I, this product is classed as category 9 "Monitoring and Control Instrumentation" product. Do not dispose of this product as unsorted municipal waste. Go to Fluke's website for recycling information.		

## Unpack the Product

Carefully unpack all items from the box and check that you have these items:

- ProSim™ 4
- Getting Started Manual
- Users Manual CD
- Carrying Case
- Power Cord
- AC/DC Power Supply
- Manual Inflation Bulb
- NIBP Cuff Adapters

## Accessories

Available Product accessories are shown in Tables 3 and 4.

**Table 3. Standard Accessories**

Item		Fluke Biomedical Part Number
ProSim™ 4 Getting Started Manual		3931478
ProSim™ 4 Users Manual CD		3931519
AC/DC Power Supply		3978380
AC Power Cord	US	284174
	Schuko	769422
	UK	769455
	Japan	284174
	Australia	658641
	Brazil <sup>[1]</sup>	3841347
Manual inflation bulb		2461946
Set of NIBP Cuff Adapters		2391882
Carrying Case		4026799
[1] Product shipped to Brazil also includes a US power cord.		

**Table 4. Optional Accessories**

Item	Fluke Biomedical Part Number
Battery pack	4026823
USB Cable, Mini Series B, 1 meter long	4034393
NIBP Mandrel Set	4308086
Modules to convert ECG snap adapter to 4 mm and 3.2 mm ECG banana adapter as part of optional accessories – For International use only	4026551
IBP Cables	See your Fluke Biomedical Distributor

## Instrument Familiarization

Table 5 is a list of Product controls and connections.

**Table 5. Product Controls and Connections**

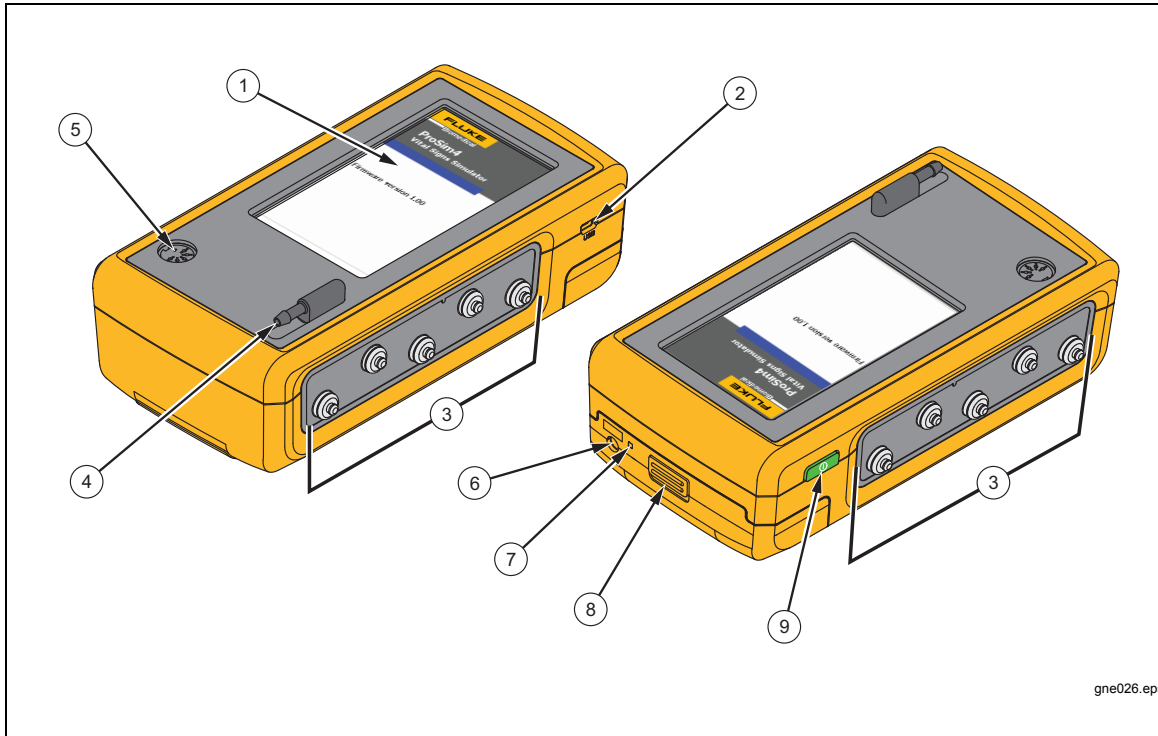

gne026.eps

Item	Name	Description
①	LCD Display	Color LCD touch-sensitive display
②	Mini-Series B Connector	For firmware updates and calibration
③	ECG Posts	Connection posts for Device Under Test (DUT) ECG leads
④	Air Port Connector	Pressure port for NIBP cuff and monitor
⑤	IBP Channel 1 Connector	Connector to an IBP input of the patient monitor
⑥	DC Power Connector	Connector for the AC/DC power supply
⑦	Battery LED	Indicates when the battery is charged
⑧	Battery Latch	Locks battery in the Product
⑨	Power Button	Turns on and off the Product

Table 6 is a list of display features.

**Table 6. Display Features**

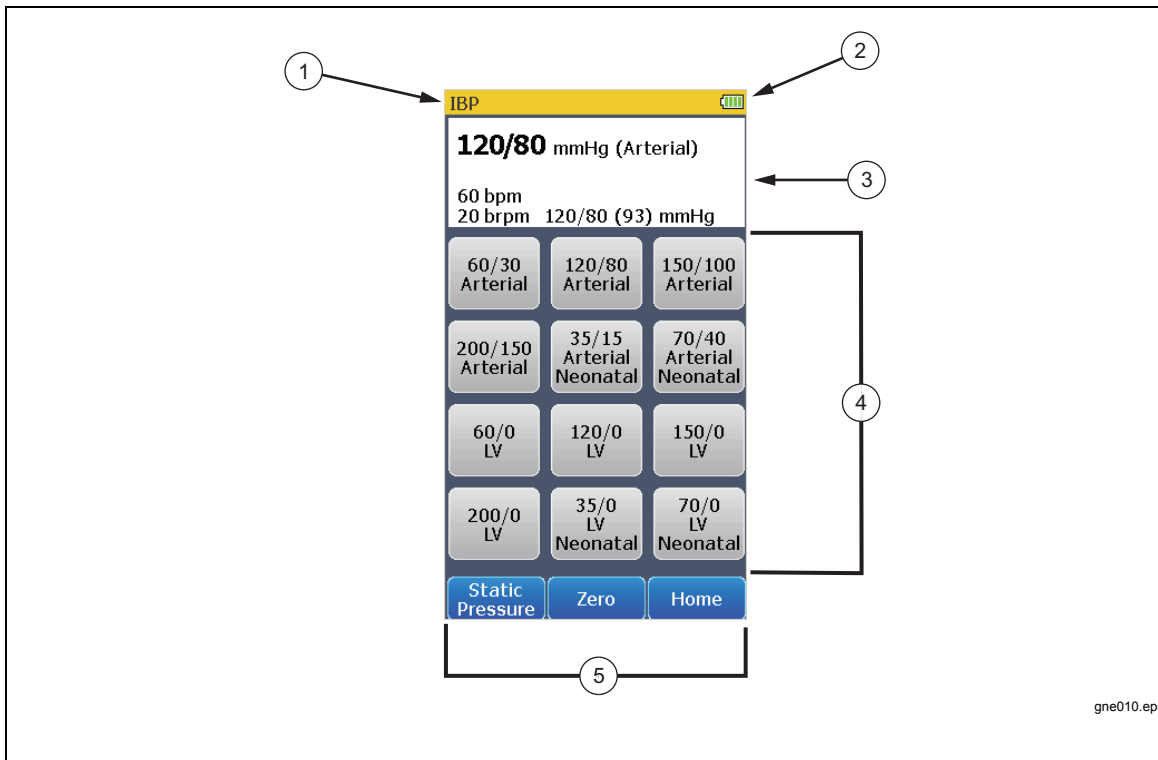



gne010.eps

Item	Name	Description
①	Name	Screen name
②	Battery	ICON that indicates the charge level of the battery.
③	Simulation parameters	Shows the simulation parameter values
④	Controls	Touch sensitive controls to set simulation parameters and Product features.
⑤	Softkeys	Three touch sensitive controls that activate the function shown inside the control.



## How to Turn On the Product

Push  on the left side panel to turn on the Product. Push  for three seconds to turn off the Product.

When the self test is complete and no errors are sensed, page 1 of the Home screen in Figure 1 shows in the display. All Product simulations and tests are set through the controls on the Home screen.

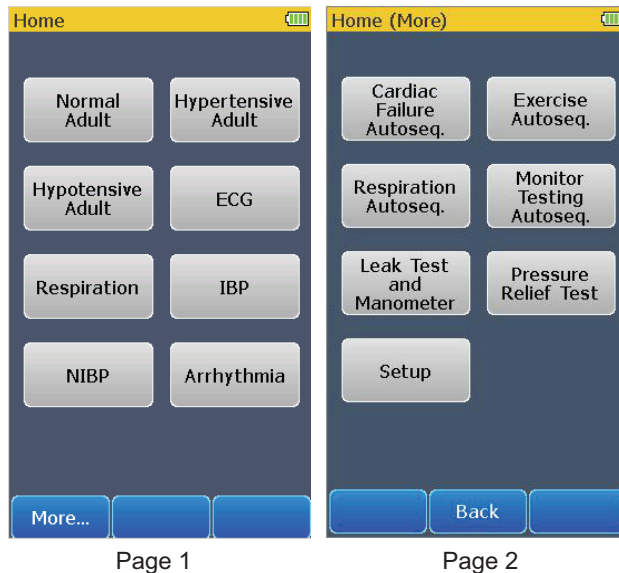

Figure 1. Home Screen

gne002.eps

### Note

*When page 1 or page 2 of the Home screen shows in the display, all simulation outputs are disabled.*

From page 1 of the Home screen, three pre-defined conditions for simulations can be used to set all the simulation functions. These pre-defined conditions are set when you touch **Normal Adult**, **Hypertensive Adult**, or **Hypotensive Adult** on the display. The pre-defined simulation variables can not be changed. Table 7 lists the parameter values for each pre-defined simulation.

Table 7. Pre-Defined Patient Simulations

Simulation Name	Parameter	Pre-Set Value
Normal	Wave Form	NSR (Adult)
	ECG Rate	60 bpm
	Respiration Rate	20 bpm
	IBP Channel 1	120/80 mmHg (Art)
	NIBP	120/80 (93) mmHg
Hypertensive	Wave Form	NSR (Adult)
	ECG Rate	120 bpm
	Respiration Rate	40 bpm
	IBP Channel 1	200/150 mmHg (Art)
	NIBP	200/150 (167) mmHg
Hypotensive	Wave Form	NSR (Adult)
	ECG Rate	40 bpm
	Respiration Rate	10 bpm
	IBP Channel 1	60/0 mmHg (LV)
	NIBP	60/30 (40) mmHg

Control of heart rate, respiration, invasive blood pressure, and non-invasive blood pressure simulations are also accessed through the controls on page 1 of the Home screen. A number of arrhythmias are set through the **Arrhythmia** control. Refer to the applicable section to learn more about each simulation function.

To show page 2 of the Home screen, push the **More** softkey. Page 2 shows controls that access autosequences, pressure and leak tests, and all setup parameters. To go back to page 1 of the Home screen, push the **Back** softkey.

## ECG Simulation

The Product simulates normal heart signals (ECG) as well as a variety of heart arrhythmias. You set adult or neonatal simulation and change the heart rate (beats per minute) through the **ECG** control.

To measure the ECG performance of a monitor, connect the Product to the monitor as shown in Figure 2. A maximum of ten ECG leads can be connected to the Product.

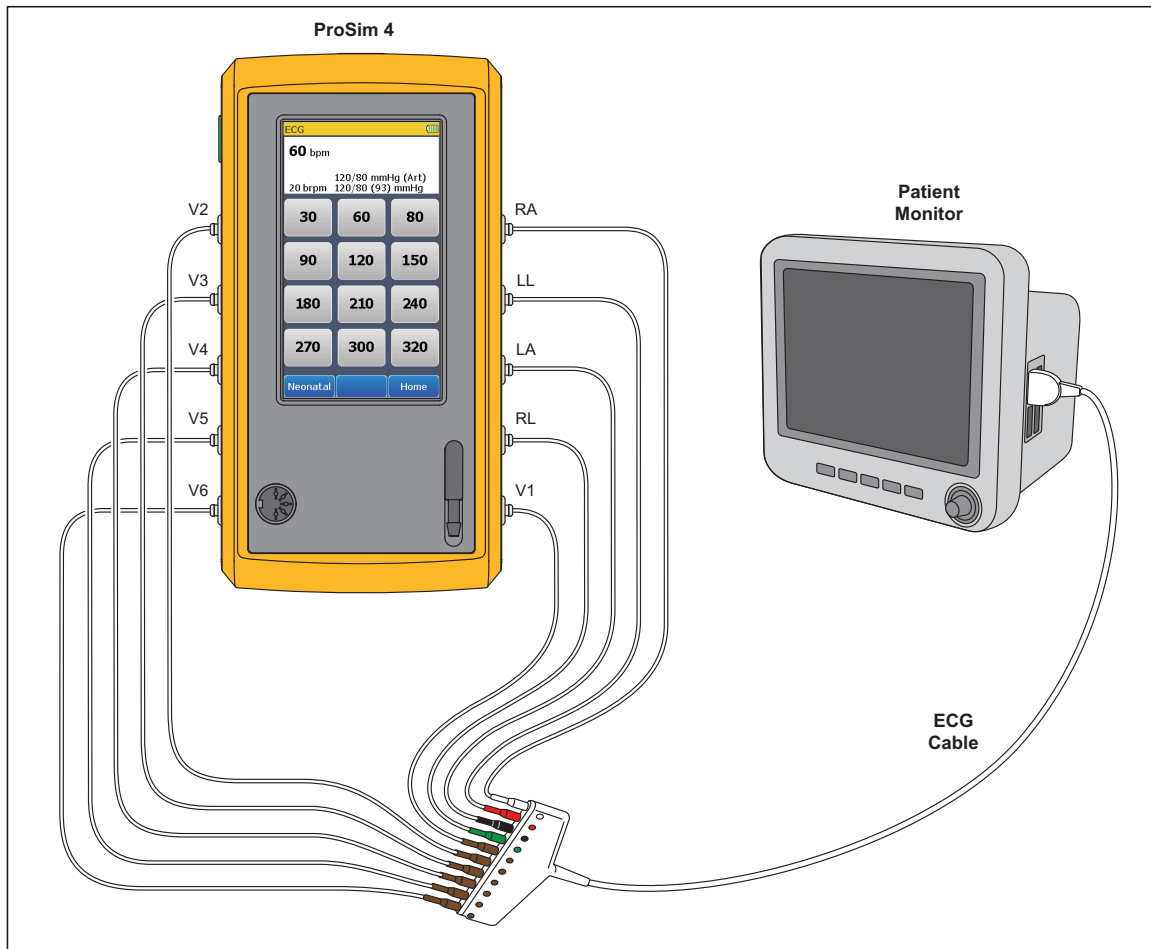

Figure 2. ECG Connections

gne018.eps

Touch the **ECG** control in the Home screen to show the screen in Figure 3 in the display.

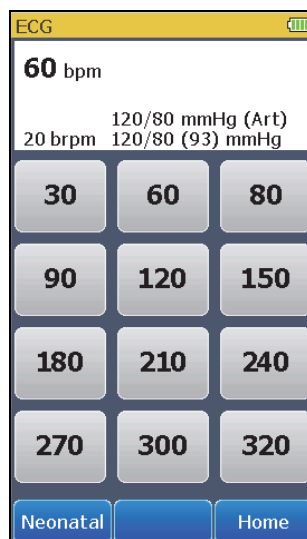

Figure 3. ECG Screen

gne003.bmp

Heart rate, respiration, invasive blood pressure, and non-invasive blood pressure parameters are shown at the top of the screen. To change the heart rate, touch one of the pre-defined heart rate controls in the display.

The ECG function can be set to an adult or neonatal ECG signal. To change between Adult and Neonatal, touch the softkey control in the lower-left corner of the display. The softkey text will change to the one value not set. For example, when **Neonatal** is shown in the softkey, an adult ECG signal is simulated.

Touch the **Home** softkey to go back to the Home screen.

Table 8 shows the percentage of the signal amplitude value that is put on each ECG lead.

Table 8. ECG Lead Amplitudes

Waveform	I	II	III	V1	V2	V3	V4	V5	V6
Normal Sinus & Performance	70 %	100 %	30 %	24 %	48 %	100 %	120 %	112 %	80 %

## Arrhythmia Simulation

The Product can simulate a number of arrhythmias on the ECG leads. As well as physiological waveforms, the Product can supply a signal to measure the performance of an ECG monitor. To do an arrhythmia simulation or do a monitor test with a performance wave, touch the **Arrhythmia** control in the Home screen. Page 1 of the screens in Figure 4 shows in the display.

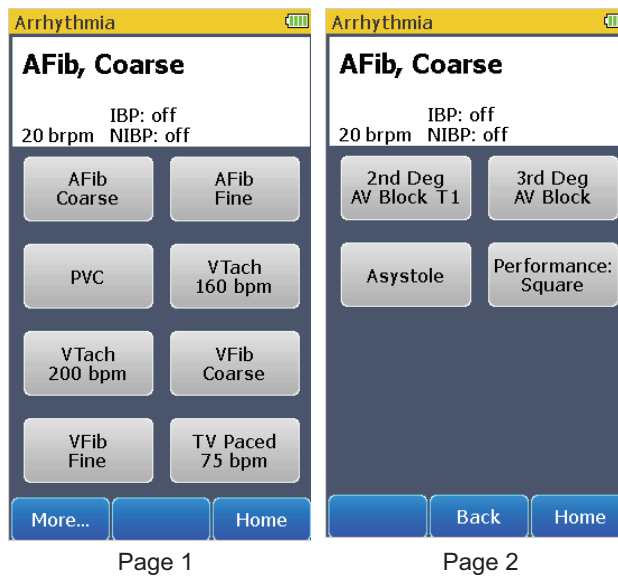

Figure 4. Arrhythmia Screens

gne008.bmp

### How to Set an Arrhythmia ECG Waveform

Connect the Product to an ECG monitor as shown in Figure 2. The Product sets the coarse atrial fibrillation waveform when the Arrhythmia screen shows in the display. There are eight arrhythmia waveform controls shown in page 1 of the Arrhythmia screen. Controls for more arrhythmia waveforms and a performance wave are shown in page 2 when the **More** softkey is touched.

The simulated arrhythmia waveform and the respiration rate are shown at the top of the display. The invasive and non-invasive blood pressure simulations are disabled when an arrhythmia waveform is simulated. To change the arrhythmia waveform, touch an arrhythmia control in page 1 or page 2 of the Arrhythmia screens.

Touch the **Home** softkey to go back to the Home screen.

### How to Output a Performance Wave

One performance wave can be output on the ECG leads for an ECG monitor test. To output a square wave on the ECG leads:

1. Touch the **Arrhythmia** control in the Home screen.
2. Touch the **More** softkey to show page 2 of the Arrhythmia screens.
3. Touch the **Performance: Square** control in the display.

A square wave is output on the ECG leads until a control is touched or the **Home** softkey is touched.

Touch the **Home** softkey to go back to the Home screen.

## Respiration Simulation

The Product simulates respiration on the left leg or left arm ECG lead. To set a respiration simulation parameter, touch the **Respiration** control in the Home screen to show the screen in Figure 5 in the display.

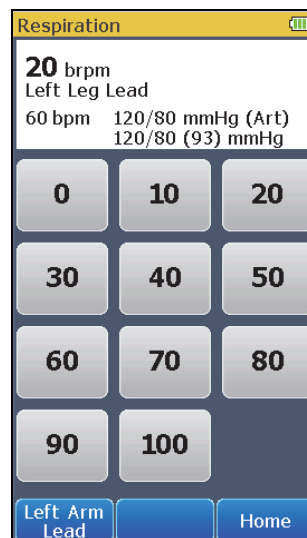

Figure 5. Respiration Screen

gne004.bmp

The breaths per minute (brpm), heart rate (bpm), invasive and non-invasive blood pressure simulation parameters are shown at the top of the display. To set the breath rate, touch one of the pre-defined respiration rates shown in the display.

To change which ECG lead the respiration simulation will be on, touch the softkey in the lower-left corner of the display.

The softkey text will change to the one value not set. For example, when **Left Arm Lead** is shown in the softkey, the respiration simulation will be on the left leg ECG lead.

Touch the **Home** softkey to go back to the Home screen.

## Non-Invasive Blood Pressure Simulation and Tests

The Product simulates blood pressure for non-invasive blood pressure monitors. Each blood pressure variable can be set through the display controls. The Product also does leak and pressure relief tests.

### How to Set the Non-Invasive Blood Pressure Parameters

To do a non-invasive blood pressure simulation, connect the Product to a blood pressure cuff and monitor as shown in Figure 6.

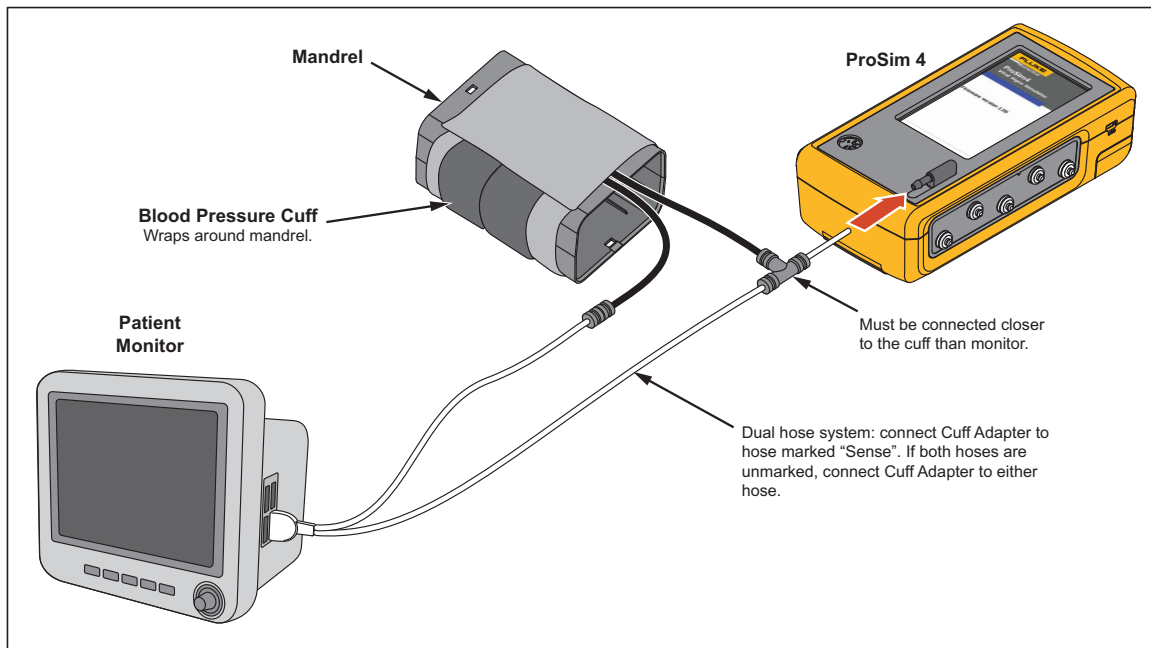
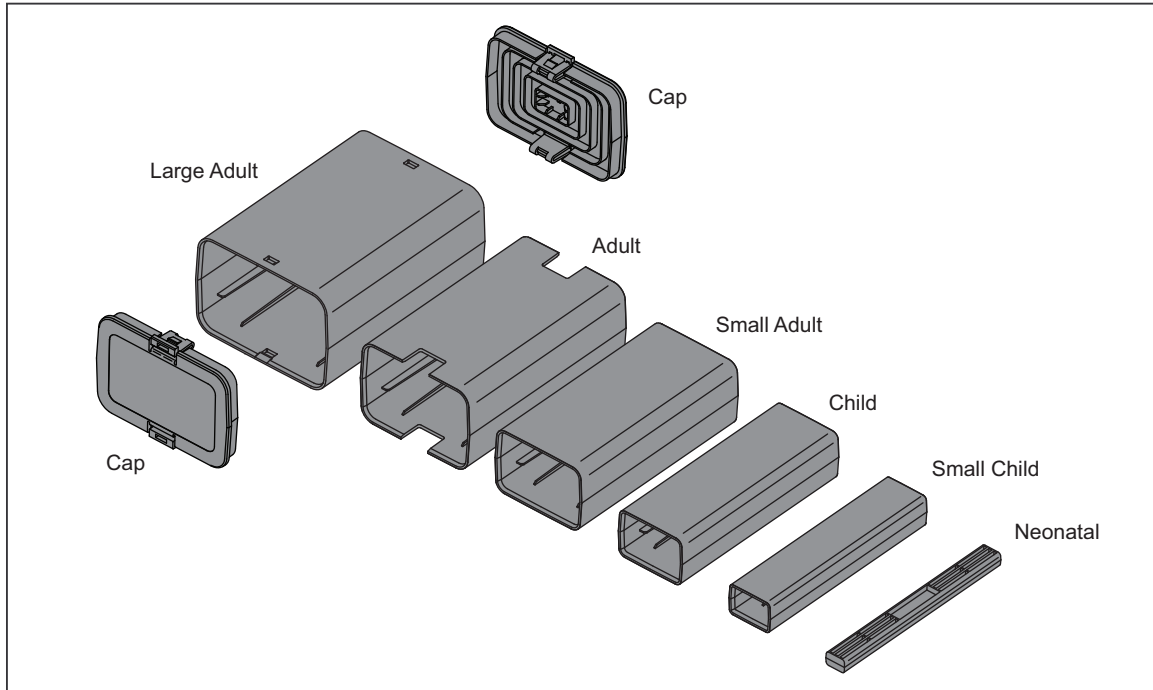

Figure 6. Non-Invasive Blood Pressure Test Connections

gne020.eps

Figure 7 shows the blood pressure cuff mandrel sizes.



**Figure 7. Blood Pressure Cuff Mandrel Sizes**

fvc011.eps

To access the non-invasive blood pressure parameters, touch the **NIBP** control in the Home screen to show the screen in Figure 8 in the display.

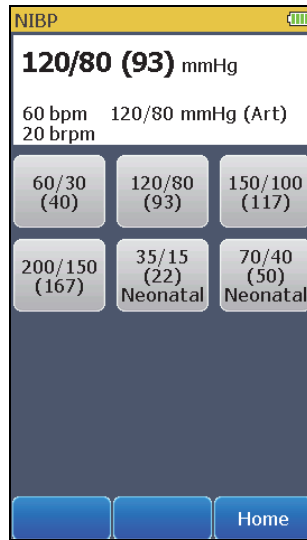

Figure 8. Non-Invasive Blood Pressure Screen

gne005.bmp

The non-invasive blood pressure, heart rate, respiration, and the invasive blood pressure parameters are shown at the top of the display. To change the non-invasive blood pressure, touch one of the pre-defined blood pressure controls in the display.

The Product can simulate four adult and two neonatal blood pressures. When set, the pulse volume is set to the default for that simulation: 1.0 ml for Adult, 0.5 ml for Neonatal.

Touch the **Home** softkey to go back to the Home screen.

### How to Do an NIBP Monitor Test

To do an accuracy test on an NIBP monitor:

1. Connect the NIBP monitor to the Product as shown in Figure 6.
2. Start an NIBP pressure cycle on the monitor. Refer to the monitor manual as necessary. After you start the blood pressure measurement cycle:
  - The blood pressure cuff inflates around the mandrel.
  - The Product starts blood pressure simulation when the pressure is over 10 mmHg. The heart beat simulation starts and stops at the systolic and diastolic pressures set into the Product.
  - The NIBP monitor interprets and shows the measured blood pressure values and heart rate when the test stops.

### How to Do a Pressure Relief Test

The pressure relief test measures the pressure in a pneumatic system until the Product senses a drop in pressure as occurs when the relief valve opens. Or the test stops if the pressure gets to the target pressure and no relief is sensed.

#### Note

*Put the NIBP monitor in “calibrate” or “service” mode to close the vent valve, so the user can inflate the pneumatic system. Refer to the service manual for the NIBP monitor.*



To do a pressure relief test:

1. Touch the **More** softkey in the Home screen.
2. Touch the **Pressure Relief Test** control to show the screen in Figure 9 in the display.

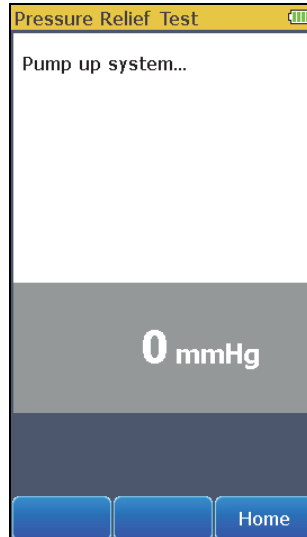

Figure 9. Pressure Relief Test Screen

gne009.bmp

3. Manually increase the pressure in the NIBP pneumatic system.

When the Product senses a sharp drop in pressure, the test stops. The Product shows “Relief Valve = Tripped” in the display and the measured pressure when the valve opened. It is recommended you do three pressure relief tests in case the relief valve is intermittent. To do the pressure relief test again, touch the **Clear** softkey and do step 3 above.

Touch the **Home** softkey to go back to the Home screen.

### How to Do a Leak Test

The leak test measures leaks in a non-invasive blood pressure monitor, the hoses connected to the monitor, and the pressure cuff.

#### Note

*Before you do a pressure leak test on a monitor, do the pressure leak test without the monitor. This measures the leak rate of the hoses and pressure cuff. Use this leak rate to offset the rate of the full system with the monitor connected.*

#### Note

*Put the NIBP monitor in “calibrate” or “service” mode to close the vent valve, so the user can inflate the pneumatic system. Refer to the service manual for the NIBP monitor.*

#### Note

*If the NIBP device has an internal system leak test or one that vents the cuff inflation pneumatic circuit to the atmosphere when idle, refer to the NIBP monitor operators manual for the recommended test protocol.*

Connect the Product to the monitor and cuff as shown in Figure 6.

To do a leak test:

1. Touch the **More** softkey.
2. Touch the **Leak Test and Manometer** control to show the screen shown in Figure 10 in the display.

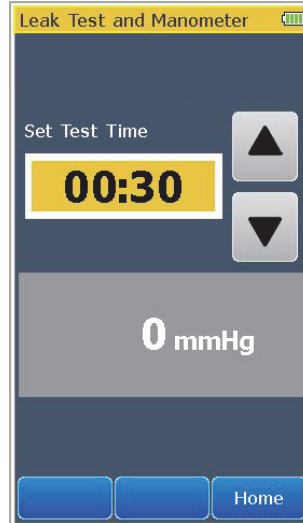

Figure 10. Leak Test Screen

gne011.bmp

3. Touch  or  to set the test time for the leak test. The maximum test time is 5 minutes and the minimum test time is 30 seconds (default).
4. Manually increase the pressure in the pneumatic system to the pressure at which the test is to start. When the measured pressure is 10 mmHg or higher, the left softkey shows **Start**.
5. Touch the **Start** softkey. The timer counts down the test time.

When the time expires, the leak rate is shown in the display. See Figure 11.

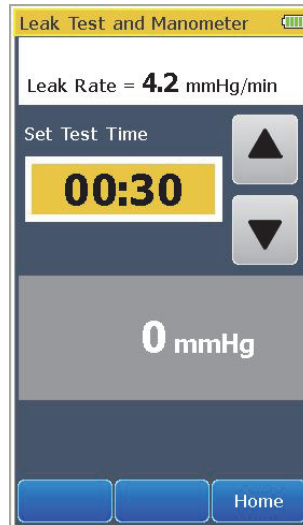

Figure 11. Leak Test Results Screen

gne025.bmp

Touch the **Home** softkey to go back to the Home screen.

### How to Check a Manometer

To check a manometer, connect the Product to the manometer and manual pump bulb as shown in Figure 12.

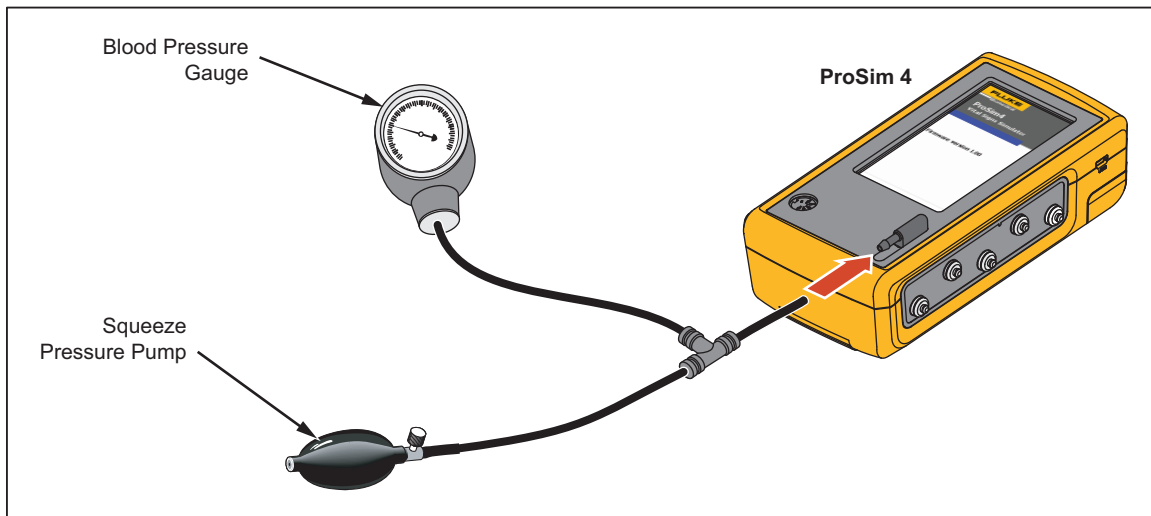

Figure 12. Manometer Check Connections

gne024.eps

1. Touch the **More** softkey.
2. Touch the **Leak Test and Manometer** control to show the screen shown in Figure 10 in the display.
3. Squeeze the manual pump bulb to pressurize the line.
4. Check the value shown on the pressure gauge against the measurement in the Product display.

Relieve the pressure through the pump relief valve before you remove the hose from the Product.

*Note*

When the battery discharges to a low level threshold, all NIBP functions may be disabled.

## Invasive Blood Pressure Simulation

The Product can simulate an invasive blood pressure transducer. To do an invasive blood pressure simulation, connect the Product to the monitor as shown in Figure 13.

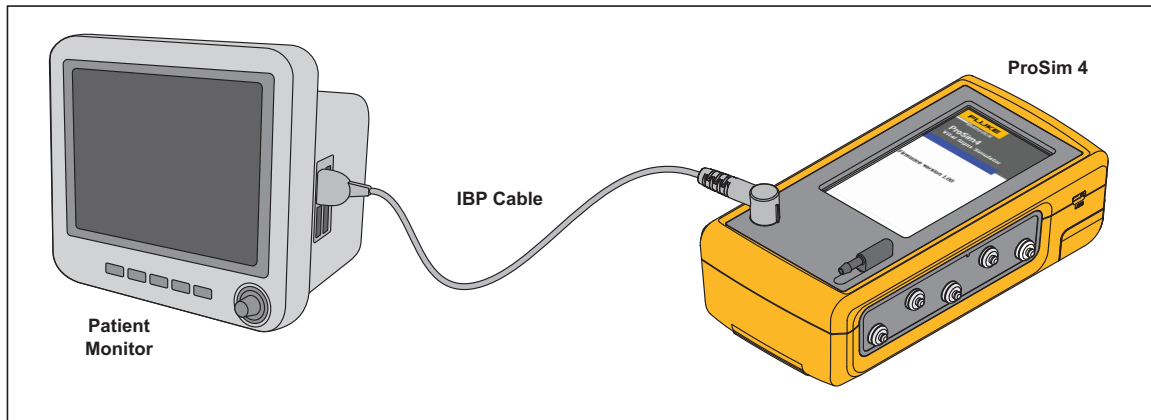

Figure 13. Invasive Blood Pressure Connections

gne021.eps

To access the invasive blood pressure parameters, touch the **IBP** control in the **Home** screen to show the screen in Figure 14 in the display.

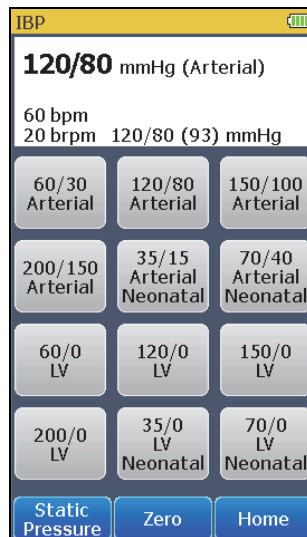

Figure 14. Invasive Blood Pressure Screen

gne006.bmp

The invasive blood pressure, heart rate, respiration, and the non-invasive blood pressure parameters are shown at the top of the display. To change the invasive blood pressure, touch one of the pre-defined blood pressure controls in the display.

To zero the simulated output, touch the **Zero** softkey.

To set a static IBP pressure signal to the IBP monitor, touch the **Static Pressure** softkey from the IBP screen. The static pressure screen in Figure 15 shows in the display.

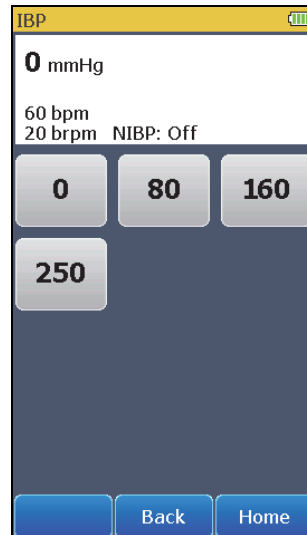

Figure 15. Static Pressure Screen

gne007.bmp

To set the simulated pressure, touch one of the pre-defined static pressure controls.

Touch the **Home** softkey to go back to the Home screen.

## Autosequences

Autosequences are a series of steps that change the output of the Product automatically. For example, to do a monitor test, you could set normal ECG then wait some time. Then touch **Hypertensive** and wait more time, then touch **Hypotensive** and wait. The monitor testing autosequence does these changes for you automatically. Each step of the monitor testing autosequence sets simulation parameters and after the allotted time period, it does the subsequent step.

To do an autosequence:

1. Touch the **More** softkey if it is shown in the Home screen.
2. Touch one of the autosequence controls to show the autosequence steps in the display. The Monitor Testing autosequence is shown in Figure 16.

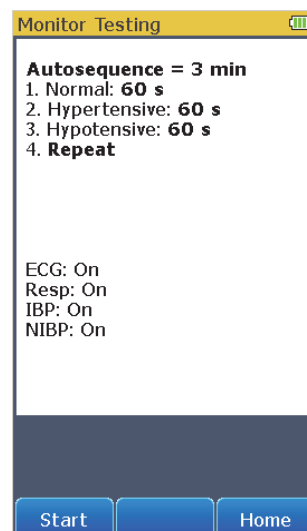

Figure 16. Monitor Testing Autosequence Screen

gne012.bmp

The autosequence above, shows the sequence steps. Some autosequences stop at the last step. The screen also shows that the length of time to complete the autosequence is 3 minutes and the length of time for each step is 60 seconds.

Touch the **Home** softkey to go back to the second page of the Home screen.





3. Touch the **Start** softkey to start the sequence and show the screen in Figure 17 in the display.



Figure 17. Monitor Testing Autosequence Steps Screen

gne013.bmp

The top part of the display shows the simulation parameters and their values. These parameter values update at each autosequence step. The middle part of the display shows which step the autosequence is on and how much time is left for the step. The sequence timer shows the length of time to complete all steps of the autosequence. If this is an autosequence that repeats, the sequence timer resets to total sequence time when the sequence starts step one.

Push  to abort the step and move to the subsequent step. When the autosequence has moved to step two,  shows in the display. Touch  to pause the step.  shows in the display when the auto sequence is paused. Push  to continue the step for the time left when the step was paused.

To abort the autosequence, touch the **Stop** softkey and go back to the autosequence view screen.

Table 9 is a list of autosequences that are built into the Product.

**Table 9. Autosequences**

Autosequence	Sequence Steps	Run Time
Cardiac Failure	ECG 80 bpm, IBP Off, NIBP Off, and Respiration Off	00:45
	ECG PVC (LV), IBP Off, NIBP Off, and Respiration Off	00:30
	ECG VTach (LV) 160 bpm, IBP Off, NIBP Off, and Respiration Off	00:30
	ECG VFib Coarse, IBP Off, NIBP Off, and Respiration Off	00:30
	ECG Asystole, IBP Off, NIBP Off, and Respiration Off	00:15
	STOP	Total Time 02:30
Exercise	ECG 60 bpm, IBP Off, NIBP Off, and Respiration Off	00:30
	ECG 90 bpm, IBP Off, NIBP Off, and Respiration Off	00:30
	ECG 120 bpm, IBP Off, NIBP Off, and Respiration Off	00:30
	ECG 150 bpm, IBP Off, NIBP Off, and Respiration Off	00:30
	ECG 90 bpm, IBP Off, NIBP Off, and Respiration Off	00:30
	ECG 60 bpm, IBP Off, NIBP Off, and Respiration Off	00:30
	REPEAT	Total Time 03:00
Respiration	ECG 60 bpm, IBP Off, NIBP Off, and Respiration 110 brpm	00:30
	ECG 60 bpm, IBP Off, NIBP Off, and Respiration 60 brpm	00:30
	ECG 60 bpm, IBP Off, NIBP Off, and Respiration 20 brpm	00:30
	ECG 60 bpm, IBP Off, NIBP Off, and Respiration 0 brpm (Apnea)	00:12
	REPEAT	Total Time 01:42
Monitor Testing	ECG 120 bpm, IBP 200/150 (Art), NIBP 200/150 (167), and Respiration 40 brpm	01:30
	ECG 60 bpm, IBP 120/80 (Art), NIBP 120/80 (93), and Respiration 20 brpm	01:30
	ECG 40 bpm, IBP 60/0 (LV), NIBP 60/30 (40), and Respiration 10 brpm	01:30
	STOP	Total Time 04:30

## Setup Features

The Product has a number of functions that are accessed through the **Setup** control. Touch the **Setup** control on page 2 in the Home screen to show the Setup screen in Figure 18 in the display.



Figure 18. Setup Screen

gne014.bmp

Touch the **Home** softkey to go back to the Home screen.

### How to Set the Backlight Intensity Level

To change the intensity level of the backlight:

1. From the Setup screen, touch the **Backlight** control to show the screen in Figure 19 in the display.

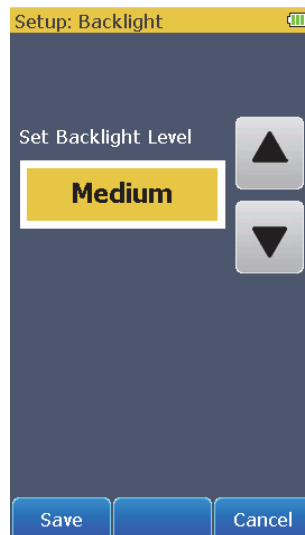

Figure 19. Backlight Screen

gne017.bmp



2. Touch ▲ or ▼ to increase or decrease the backlight level. There are only three levels: High, Medium, and Low.
3. Touch the **Save** softkey to set the level and go back to the Setup screen.

Touch the **Cancel** softkey to go back to the Setup screen and not change the backlight intensity.

### **How to Change the Language for the Display**

To change the language in the display:

1. From the Setup screen, touch the **Language** control to show the screen in Figure 20 in the display.



Figure 20. Language Screen

gne015.bmp

2. Touch ▲ or ▼ to scroll through the languages.
3. Touch the **Save** softkey to set the language and go back to the Setup screen.

Touch the **Cancel** softkey to go back to the Setup screen and not change the language.

### How to Show Instrument Information in the Display

To show the Product information in Figure 21 in the display, touch the **Instrument Information** control in the Setup screen.



Figure 21. Instrument Information Screen

gne016.bmp

#### Note

*Firmware version shown is for illustration only and may not match the latest firmware.*

Touch **Back** to go back to the Setup screen. Touch the **Home** softkey to go back to the Home screen.

### Maintenance

The Product is a calibrated measurement instrument. Try to prevent mechanical abuse that could change the calibrated values. The Product has no internal user-serviceable parts.

#### Warnings

**For safe operation and maintenance of the Product:**

- **Do not keep cells or batteries in a container where the terminals can be shorted.**
- **Connect the battery charger to the mains power outlet before the Product.**
- **Repair the Product before use if the battery leaks.**
- **Remove batteries to prevent battery leakage and damage to the Product if it is not used for an extended period.**
- **Keep cells and battery packs clean and dry. Clean dirty connectors with a dry, clean cloth.**
- **Do not short the battery terminals together.**
- **Use only Fluke Biomedical approved power adapters to charge the battery.**

To prevent personal injury:

- Do not disassemble the battery.
- Batteries contain hazardous chemicals that can cause burns or explode. If exposure to chemicals occurs, clean with water and get medical aid.
- Do not put battery cells and battery packs near heat or fire. Do not put in sunlight.
- Do not disassemble or crush battery cells and battery packs.

To prevent possible electrical shock, fire, or personal injury:

- Remove the input signals before you clean the Product.
- Use only specified replacement parts.
- Have an approved technician repair the Product.

### **How to Clean the Product**

#### **⚠ Caution**

**Do not pour fluid onto the Product surface; fluid seepage into the electrical circuitry may cause the Product to fail.**

**Do not use spray cleaners on the Product; such action may force the cleaning fluid into the Product and damage electronic components.**

Clean the Analyzer occasionally with a damp cloth and mild detergent. Try to prevent the entrance of liquids.

Clean the adapter cables with the same precautions. Examine them for damage and deterioration of the insulation. Examine the connections for integrity. Keep the transducer adapter clean and dry.

### **Battery Maintenance**

For peak battery performance, charge the Product to maximum charge once a month. If the Product is not to be used for more than a month, keep it connected to the charger.

#### *Note*



*To get the specified performance, use the specified battery charger that comes with this Product.*

When the battery gets low a low battery message shows in the display.

When the battery discharges to a low level threshold, a warning message shows in the display to indicate the NIBP function is disabled.

### How to Charge the Battery

The battery charge level is shown in the upper right corner of the display.

-  Shows when the ac/dc power supply is connected
-  Shows the battery level when the Product operates on the battery

The battery can be charged while it is in or out of the Product. The charge rate is slower when the Product is energized and the battery charger is on. To charge the battery:

1. As shown in Figure 22, connect the ac/dc power supply to the power connector on the battery pack.
2. Connect the ac/dc power supply to a power source.

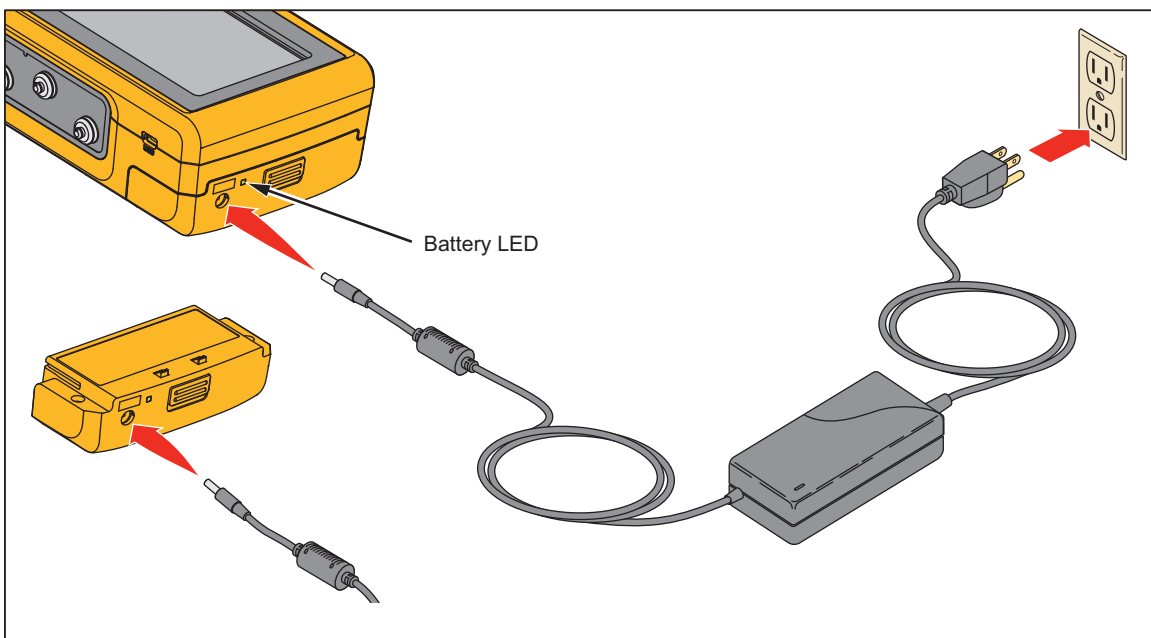

Figure 22. External Battery Charging Connections

gne022.eps

The battery charge LED on the battery pack shows red or green when the ac/dc power supply is connected to the battery pack. When the LED is green, the battery is charged.

When you have two or more battery packs, you can charge one battery externally while you use the other to energize the Product.

### Battery Removal

The battery pack is easy to remove and replace. To remove the battery pack:

1. Push down on the battery pack latch as shown in Figure 23.
2. Pull the battery pack from the Product.

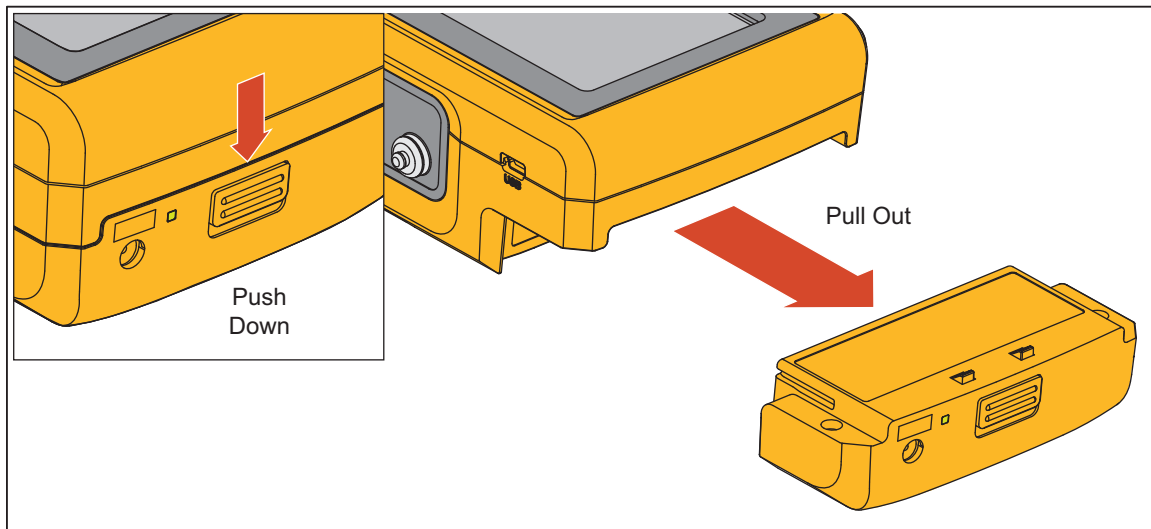

**Figure 23. Battery Removal**

gne023.eps

To put the battery pack into the Product, align the battery pack with the guides on the Product and push it into the Product until the latch locks.

The ProSim 4 battery is not compatible with the ProSim 6/8.

### General Specifications

#### Temperature

Operating .....	10 °C to 40 °C (50 °F to 104 °F)
Storage .....	-20 °C to +60 °C (-4 °F to +140 °F)

**Humidity**..... 10 % to 90 % non-condensing

**Altitude**..... 3,000 meters (9,843 ft)

**Size (L x W x H)**..... 18.0 cm x 9.3 cm x 5.5 cm (7.1 in x 3.7 in x 2.2 in)

**Display**..... LCD Touch-Screen Color Display

**Communication**..... USB Port (for calibration and firmware updates only)

**Power**..... Lithium-Ion rechargeable battery, 10.75 Wh, 3.7 V, 2900 mAh

**Battery Charger**..... 110 to 220 Vac, 50/60 Hz input, 6 V/3.5 A output. For best performance, the battery charger should be connected to a properly grounded ac receptacle

**Battery Life**..... 4 hours (minimum), 40 NIBP cycles typical

**Weight**..... 0.88 kg (1.93 lb)

**Safety**..... IEC 61010-1: Category II, Pollution Degree 2

**Electromagnetic Compatibility (EMC)**

International .....	IEC 61326-1: Basic Electromagnetic Environment CISPR 11: Group 1, Class A <i>Group 1: Equipment has intentionally generated and/or uses conductively-coupled radio frequency energy that is necessary for the internal function of the equipment itself.</i> <i>Class A: Equipment is suitable for use in all establishments other than domestic and those directly connected to a low-voltage power supply network that supplies buildings used for domestic purposes. There may be potential difficulties in ensuring electromagnetic compatibility in other environments due to conducted and radiated disturbances.</i> <i>Emissions that exceed the levels required by CISPR 11 can occur when the equipment is connected to a test object.</i>
USA (FCC).....	47 CFR 15 subpart B

**Detailed Specifications**

**Normal-Sinus-Rhythm Waveform**

<b>ECG Reference</b> .....	The ECG amplitudes specified are for Lead II (calibration), from the baseline to the peak of the R wave. All other leads are proportional.
<b>Normal Sinus Rhythm</b> .....	12-lead configuration with independent outputs referenced to right leg (RL). Output to 10 Universal ECG Jacks, color-coded to AHA and IEC Standards.
<b>Amplitude</b> .....	1.0 mV. Other leads are proportional to Lead II (reference lead) in percentage per:
Lead I .....	70
Lead II .....	100
Lead III .....	30
Lead V1 .....	24
Lead V2 .....	48
Lead V3 .....	100
Lead V4 .....	120
Lead V5 .....	112
Lead V6 .....	80
<b>Amplitude Accuracy</b> .....	±5 % of setting Lead II
<b>ECG Rate</b> .....	30, 60, 80, 90, 120, 150, 180, 210, 240, 270, 300, and 320 BPM (Preset Hypotensive condition is at 40 BPM)
<b>Rate Accuracy</b> .....	±1 % of setting
<b>ECG Waveform Selection</b> .....	Adult (80 ms) or neonatal (40 ms) QRS duration
<b>Power-On Default</b> .....	60 BPM, 1.0 mV, adult QRS

**Arrhythmia**

<b>Atrial Fibrillation</b> .....	Coarse or fine
<b>Premature Ventricular Contraction</b> .....	Left Ventricular
<b>Ventricular Tachycardia</b> .....	160 or 200 BPM
<b>Ventricular Fibrillation</b> .....	Coarse or fine.
<b>Transvenous Pacer Pulse</b> .....	75 BPM, left arterial, 3 mV amplitude on lead II, Accuracy ±10 %, 1.0 ms width
<b>2nd Degree AV Block</b> .....	Type 1
<b>3rd Degree AV Block</b>	
<b>Asystole</b>	

### ECG-Performance-Testing

**Amplitude** ..... 1 mV. Other leads are proportional to Lead II (reference lead) in percentage per:

Lead I ..... 70

Lead II ..... 100

Lead III ..... 30

Lead V1 ..... 24

Lead V2 ..... 48

Lead V3 ..... 100

Lead V4 ..... 120

Lead V5 ..... 112

Lead V6 ..... 80

**Square Wave** ..... 60 ms at 2.0 Hz

### Respiration

**Rate** ..... 0 (OFF), 10 to 100 BrPM in 10 BrPM steps

**Impedance Variations ( $\Delta \Omega$ )** ..... 1  $\Omega$

**Accuracy Delta** .....  $\pm(10\% + 0.05 \text{ ohm})$

**Baseline** ..... 500  $\Omega$  to circuit common, giving 1000  $\Omega$  between any two leads

**Accuracy Baseline** .....  $\pm 5\%$

**Respiration Lead** ..... LA or LL (default)

### Invasive Blood Pressure

**Channels** ..... 1 electrically isolated from all other signals

**BP Output** ..... Circular DIN 5-Pin

**Input/output Impedance** ..... 300  $\Omega \pm 10\%$

**Exciter Input Range** ..... 2.0 to 16.0 V peak

**Exciter-Input Frequency Range** ..... DC to 5000 Hz

**Transducer Sensitivity** ..... 5  $\mu\text{V/V/mmHg}$

**Pressure Accuracy** .....  $\pm(1\% \text{ of setting} + 1 \text{ mmHg})$  Accuracy guaranteed for DC excitation only

**Static Pressure** ..... 0, 80, 160, and 250 mmHg

**Dynamic Waveforms**

Synchronization ..... To ECG heartrate

Chambers simulated systolic/diastolic pressure:

Type	IBP (Arterial)	IBP (Left Ventricular)
Adult	60/30	60/0
Adult	120/80	120/0
Adult	150/100	150/0
Adult	200/150	200/0
Neonatal	35/15	35/0
Neonatal	70/40	70/0

### Non-Invasive Blood Pressure

**Pressure Units** ..... mmHg

**Manometer (Pressure Meter)**

Range ..... 10 to 400 mmHg

Resolution ..... 0.1 mmHg (for display purposes)

Accuracy .....  $\pm(1\% \text{ reading} + 1 \text{ mmHg})$

**Pressure Source** ..... Inflation bulb or device under test

**NIBP Simulations**

Pulse .....	2 mmHg max into 500 ml NIBP system
Volume of air moved .....	1.0 ml max
Simulations .....	Systolic/diastolic (MAP)
Adult .....	60/30 (40), 120/80 (93); 150/100 (117); and 200/150 (167)
Neonatal .....	35/15 (22) and 70/40 (50)
Repeatability .....	Within $\pm 2$ mmHg (at maximal pulse size independent of device under test)
Synchronization .....	To ECG heartrate (maximal rate 120 BPM)

**Leak Test**

Target Pressure .....	20 to 400 mmHg
Elapse time .....	0:30 to 5:00 minutes:seconds in 30 second steps
Leakage Rate .....	0 to 200 mmHg/minute
Internal Leak rate .....	<2 mmHg/min into 500 ml rigid volume

**Pressure Relief Test Range** ..... 100 to 400 mmHg

***Presets and Autosequences***

Presets

- Normal
- Hypertensive
- Hypotensive

Autosequences

- Cardiac Failure sequence
- Exercise sequence
- Respiration sequence
- Monitor testing sequence



# Appendix A

## Glossary

### Introduction

The words in this glossary are common words used in this manual that may need further explanation. Words in italics are words that are defined in this glossary.

### AAMI

Acronym for the Association for the Advancement of Medical Instrumentation. A group of physicians, biomedical and clinical engineers, nurses, manufacturers, and government representatives who set industry guidelines for the performance and safety of biomedical instrumentation.

### AC component

The *pulse* factors of the blood measured by oximetry.

### Ampere

A unit of steady electrical current which, when flowing in straight parallel wires of infinite length and negligible cross section, separated by a distance of one *meter* in free space, produces a force between the wires of  $2 \times 10^{-7}$  newtons per meter of length.

### Aorta

The main trunk of the systemic arteries, carrying blood from the left side of the heart to the arteries of all limbs and organs except the lungs.

### Apnea

Apnea is described as the cessation of breathing. In general there are three types of apnea: central (often seen in infants, when there is no diaphragm movement and no air flow); obstructive (where an object, such as food, is lodged in the trachea); and mixed (where central apnea is followed immediately by obstructive apnea).

### Artery

Any of a branching system of muscular tubes that carry blood away from the heart.

### **Asystole (Cardiac Standstill)**

No *ECG* activity whatsoever. Ventricular asystole is a critical condition characterized by the absence of a heartbeat either in the *ventricles* or in the entire heart. This condition, also referred to as *cardiac standstill*, is usually accompanied by loss of consciousness, *apnea*, and—if not treated immediately—death.

### **Atrial Fibrillation**

A rapid, irregular atrial signal, coarse or fine, with no real P waves; an irregular ventricular rate. Coarse and fine atrial fibrillation occurs when the electrical signals in the atria are chaotic, and multiple, ectopic pacemakers are firing erratically. Some impulses may conduct through to the *AV node* to stimulate the *ventricles*, causing a quite-irregular and often-rapid ventricular rate. On the *ECG* there is an absence of P waves, with an irregular R-R interval. Atrial-fibrillation *waveforms* are irregularly shaped and usually rounded. The amplitude of the atrial signal is higher for coarse, and lower for fine, fibrillation.

### **Atrium**

(1) One of the two upper chambers of the heart. (2) Any chamber allowing entrance to another structure or organ.

### **AV Junction**

A junction consisting of the *AV node* and the *bundle of His*. Conducts the electrical impulse sent from the *SA node* from the atria into the ventricles.

### **AV Node**

Also called the atrioventricular node. Located in the right *atrium* near the septum. Conducts the electrical impulse in the heart to the *bundle of His*, which passes it on to the left- and right-bundle branches.

### **Baud**

A unit of measurement that denotes the number of discrete signal elements, such as bits, that can be transmitted per second. Bits-persecond (bps) means the number of binary digits transmitted in one second.

### **Blood Pressure**

The pressure of the blood within the arteries, primarily maintained by contraction of the left *ventricle*.

### **BPM**

Beats per minute. SEE pulse.

### **Bundle-Branch Block**

Blockage in the right- or left-bundle branches, with beats exhibiting a wide QRS and a PR interval of 160 ms. Bundle-branch blockage—also referred to as intraventricular conduction defect, BBB or IVCD—is a form of *heart block* in which there is a conduction delay or failure from one of the branches of the *bundle of His* (which start about a centimeter below the bundle of His) to the *Purkinje network*. The blockage may be complete or incomplete, transient, intermittent, or permanent. In most cases, the electrical impulse travels through the normal bundle branch to stimulate one *ventricle* and then passes through the *cardiac* septum to stimulate the other, resulting in one ventricle's depolarizing later than the other. (Both anatomically and functionally, the septum separates the heart into its left and right halves.)

**Bundle Of HIS**

A collection of nerves (about 1 cm in length) that lies just below the *AV node* in the heart. Part of the heart's electrical conduction system. With the AV node, forms the *AV junction*. Below the bundle, the nerves divide into left and right branches.

**Computational Constant**

Pertaining to cardiac output. Sometimes called calibration coefficient.

**Cardiac**

Of, near, or pertaining to the heart.

**Cardiovascular**

Of, pertaining to, or involving the heart and the blood vessels.

**Capillary**

One of the minute blood vessels that connect the arteries and veins.

**DC component**

See R-Value

**ECG**

An electrocardiogram (ECG) records the electrical signals of the muscles of the heart—the depolarization and repolarization of the *myocardium*. Wires from an ECG machine are connected to small plastic or metal disks called leads, or electrodes. Put on the chest, the wrists of the right and left arms, and the left leg at the ankle, these electrodes transmit signals to a recorder. The recorder makes lines in the shape of waves on graph paper in the ECG machine, follow the heart's electrical activity (rate) and its rhythm (beat). Each contraction of a normal heart causes a normal sinus rhythm (NSR) *waveform*, also referred to as the P QRS T waveform.

**Frequent Multifocal PVCs**

A sequence that includes a left-focus PVC followed by normal beats, alternating with a right-focus PVC followed by normal beats. Frequent *multifocal PVCs* are initiated by a number of different ectopic pacemakers in the *ventricles*, with events occurring at least five times per minute, and usually more often.

**Gram**

A metric unit of mass and weight, equal to one-thousandth of a *kilogram*, about 0.035 ounces.

**Heart Block: First, Second, and Third Degree**

Three heart-block simulations, running as repeating sequences. A heart block is a condition wherein the signal generated by the *SA node* is delayed or is blocked (partially or completely) in its journey to the *ventricles*. Because this condition typically occurs at the AV (atrioventricular) junction, a more precise term for heart block is atrioventricular block. When the conduction time from the atria to the ventricles becomes delayed (usually resulting in a P-R interval greater than 0.20 seconds), it is referred to as a first-degree block. When impulses from the atria occasionally do not reach the ventricles, the block is considered partial or incomplete and is referred to as a second-degree block. Finally, when no impulses whatsoever are able to enter the ventricles from the atria, the heart block is complete and is referred to as a third-degree block. As a consequence of a third-degree block, the atria and the ventricles beat at their own separate rates.

**Hertz**

A unit of frequency equal to one cycle per second. Used to measure electrical current and light, especially ultraviolet radiation (as in fluorescent light).

**Impedance**

A measure of the total opposition to current in a circuit.

**Joule**

A unit of energy, equal to the work done when a current of one ampere is passed through a *resistance* of one *ohm* for one second.

**Kilogram**

The fundamental unit of mass in the International System, about 2.2046 pounds.

**LCD**

Liquid crystal display. A digital display consisting of a liquid crystal material between sheets of glass that becomes readable in the presence of an applied voltage.

**Meter**

The fundamental unit of length, equivalent to 39.37 inches, in the metric system.

**Millivolt**

One-thousandth of a *volt*.

**Multiple PVCs: Paired PVCs; Run 5 PVCs; Run 11 PVCs**

Three series of multiple *PVCs* run as one-time (nonrepeating) events. The term multiple *PVCs* refers to any condition where two or more *PVCs* occur in a row. Standard *PVCs* of this type include a pair of *PVCs* (also known as a couplet), a run of five *PVCs* in a row, and a run of eleven *PVCs* in a row.

**Myocardium**

The thick muscular layer of the heart, located between the endocardium at the inside and the epicardium at the outside walls of the heart.

**Nanometer**

One-billionth ( $10^{-9}$ ) of a *meter*.

**Nanosecond**

One billionth ( $10^{-9}$ ) of a second (one thousand-millionth of a second). Electricity travels approximately one foot per nanosecond.

**Nodal Rhythm**

Normal rhythm, but with a P wave that originates in the *AV node*, and a P-R interval that is very short. Nodal rhythm, also referred to as junctional rhythm or junctional escape, is a condition where the predominant pacemaker is the *AV node* rather than the *SA node*.

**Noninvasive**

Not tending to spread; especially, not tending to invade healthy tissue.

**Ohm**

A unit of electrical *resistance* equal to that of a conductor in which a current of one ampere is produced by a potential of one *volt* across its terminals.

**Patient Leads**

Cables that connect a patient directly with the monitor. Sometimes called applied parts.

**Premature Ventricular Contractions**

Six PVC-type selections of focus and timing:

- a left-focus premature ventricular beat with standard timing, 20 % premature;
- a left-focus premature ventricular beat with early timing, 33 % premature;
- a left-focus premature ventricular beat with very early timing, 65 % premature, which starts during the T wave of the previous beat;
- a right-focus premature ventricular beat with standard timing, 20 % premature;
- a right-focus premature ventricular beat with early timing, 33 % premature; or
- a right-focus premature ventricular beat with very early timing, 65 % premature, which starts during the T wave of the previous beat.

A premature ventricular contraction or PVC is an extra beat consisting of an abnormally wide and unusual *QRS complex* originating in an ectopic pacemaker in the *ventricles*. Early ventricular PVCs occur close to the preceding beat. Moreover, R-on-T PVCs, which are characterized by a beat that falls on the T wave of the preceding QRS-T complex, are especially inauspicious because of their potential to cause *ventricular tachycardia* or *ventricular fibrillation*.

**Pulse**

The rhythmical throbbing of arteries produced by regular contractions of the heart.

**Purkinje Network**

The dense collection of Purkinje fibers, which are dispersed throughout the *myocardium* and which represent the terminal portion of the heart's electrical conduction system.

**PVCS**

*Premature ventricular contractions.*

**QRS Complex**

The part of the P-QRS-T wave that records ventricular depolarization and contraction.

**R-Value**

The non-pulsating components of tissue, specifically the tissue bed, the *venous* blood, the *capillary* blood, and nonpulsatile arterial blood. Also referred to as the DC component.

**Resistance**

The opposition to electric current that is characteristic of a medium, substance, or circuit element.

**SA Node**

The dominant pacemaker site in the heart, responsible for setting the heart rate. Positioned in the right *atrium* near the inlet of the superior vena cava.

**Serial Port**

An *asynchronous* COMmunication port/address to which a peripheral—such as a printer or a mouse—is connected to a computer or other device. SEE RS-232.

### **Sinus Arrhythmia**

Beats that are normal, but triggered at an irregular rate, from 60 *BPM* to 100 *BPM*.

Sinus arrhythmia occurs when the *SA node* paces the heart irregularly. Typically, the heartbeat increases with each intake of breath and decreases with each exhalation (a condition most commonly found in young children and the elderly).

### **Ventricle**

A small anatomical cavity or chamber, as of the brain or heart, especially (1) the chamber on the left side of the heart that receives arterial blood from the left *atrium* and contracts to drive it into the *aorta*, and (2) the chamber on the right side of the heart that receives *venous* blood from the right atrium and drives it into the pulmonary *artery*.

### **Ventricular Fibrillation**

An irregular ventricular *waveform*, coarse or fine. Coarse and fine ventricular fibrillations occur when the electrical signals in the *ventricles* are chaotic, and multiple, ectopic, ventricular pacemakers are firing erratically. There are no real P waves and no clear R-R interval. Ventricular fibrillation waveforms are irregularly shaped. Ventricular fibrillation is a life-threatening condition; usually in such situations a defibrillator is applied immediately to return the heart to its normal rhythm.

### **Ventricular Tachycardia**

A faster-than-normal rhythm of beats (160 *BPM*) originating in the *ventricles*, similar to type-1 (left-focus) *PVCs*. Ventricular tachycardia is a life-threatening arrhythmia in which one or multiple, ectopic, ventricular pacemakers in the bundle branches, *Purkinje network*, or ventricular *myocardium* are firing in a heart beating more frequently than 110 times a minute. In some cases the heart will be beating at a rate above 240 *BPM*. Ventricular tachycardia usually occurs in cases of extreme *cardiac* disease and often initiates or degenerates into *ventricular fibrillation*. This type of tachycardia can reduce cardiac output by as much as 25 % due, in many cases, to the lack of an atrial “kick” and therefore the lack of a complete filling of the ventricles with blood prior to ventricle contraction.

### **Volt**

The International System unit of electric potential and electromotive force, equal to the difference of electric potential between two points on a conducting wire carrying a constant current of one ampere when the power dissipated between the points is one watt.

### **Waveform**

(1) The mathematical representation of a wave, especially a graph of deviation at a fixed point (baseline) versus time. (2) On an *ECG* tracing or output, the size, shape, and distance (in milliseconds) of a P-QRS-T complex.

### **Wavelength**

In a periodic wave, the distance between two points of corresponding phase in consecutive cycles.