

FLUKE®

Biomedical

ESA615

Electrical Safety Analyzer

Users Manual

FBC-0026

February 2012, Rev. 3, 8/15

© 2012-2015 Fluke Corporation. All rights reserved. Specifications are subject to change without notice.
All product names are trademarks of their respective companies.

Warranty and Product Support

Fluke Biomedical warrants this instrument against defects in materials and workmanship for one year from the date of original purchase OR two years if at the end of your first year you send the instrument to a Fluke Biomedical service center for calibration. You will be charged our customary fee for such calibration. During the warranty period, we will repair or at our option replace, at no charge, a product that proves to be defective, provided you return the product, shipping prepaid, to Fluke Biomedical. This warranty covers the original purchaser only and is not transferable. The warranty does not apply if the product has been damaged by accident or misuse or has been serviced or modified by anyone other than an authorized Fluke Biomedical service facility. NO OTHER WARRANTIES, SUCH AS FITNESS FOR A PARTICULAR PURPOSE, ARE EXPRESSED OR IMPLIED. FLUKE SHALL NOT BE LIABLE FOR ANY SPECIAL, INDIRECT, INCIDENTAL OR CONSEQUENTIAL DAMAGES OR LOSSES, INCLUDING LOSS OF DATA, ARISING FROM ANY CAUSE OR THEORY.

This warranty covers only serialized products and their accessory items that bear a distinct serial number tag. Recalibration of instruments is not covered under the warranty.

This warranty gives you specific legal rights and you may also have other rights that vary in different jurisdictions. Since some jurisdictions do not allow the exclusion or limitation of an implied warranty or of incidental or consequential damages, this limitation of liability may not apply to you. If any provision of this warranty is held invalid or unenforceable by a court or other decision-maker of competent jurisdiction, such holding will not affect the validity or enforceability of any other provision.

Notices

All Rights Reserved

© Copyright 2015, Fluke Biomedical. No part of this publication may be reproduced, transmitted, transcribed, stored in a retrieval system, or translated into any language without the written permission of Fluke Biomedical.

Copyright Release

Fluke Biomedical agrees to a limited copyright release that allows you to reproduce manuals and other printed materials for use in service training programs and other technical publications. If you would like other reproductions or distributions, submit a written request to Fluke Biomedical.

Unpacking and Inspection

Follow standard receiving practices upon receipt of the instrument. Check the shipping carton for damage. If damage is found, stop unpacking the instrument. Notify the carrier and ask for an agent to be present while the instrument is unpacked. There are no special unpacking instructions, but be careful not to damage the instrument when unpacking it. Inspect the instrument for physical damage such as bent or broken parts, dents, or scratches.

Technical Support

For application support or answers to technical questions, either email techservices@flukebiomedical.com or call 1-800- 850-4608 or 1-440-248-9300. In Europe, email techsupport.emea@flukebiomedical.com or call +31-40-2965314.

Claims

Our routine method of shipment is via common carrier, FOB origin. Upon delivery, if physical damage is found, retain all packing materials in their original condition and contact the carrier immediately to file a claim. If the instrument is delivered in good physical condition but does not operate within specifications, or if there are any other problems not caused by shipping damage, please contact Fluke Biomedical or your local sales representative.

Returns and Repairs

Return Procedure

All items being returned (including all warranty-claim shipments) must be sent freight-prepaid to our factory location. When you return an instrument to Fluke Biomedical, we recommend using United Parcel Service, Federal Express, or Air Parcel Post. We also recommend that you insure your shipment for its actual replacement cost. Fluke Biomedical will not be responsible for lost shipments or instruments that are received in damaged condition due to improper packaging or handling.

Use the original carton and packaging material for shipment. If they are not available, we recommend the following guide for repackaging:

- Use a double-walled carton of sufficient strength for the weight being shipped.
- Use heavy paper or cardboard to protect all instrument surfaces. Use nonabrasive material around all projecting parts.
- Use at least four inches of tightly packed, industry-approved, shock-absorbent material around the instrument.

Returns for partial refund/credit:

Every product returned for refund/credit must be accompanied by a Return Material Authorization (RMA) number, obtained from our Order Entry Group at 1-440-498-2560.

Repair and calibration:

To find the nearest service center, go to www.flukebiomedical.com/service or

In the U.S.A.:

Cleveland Calibration Lab
Tel: 1-800-850-4608 x2564
Email: globalcal@flukebiomedical.com

Everett Calibration Lab
Tel: 1-888-99 FLUKE (1-888-993-5853)
Email: service.status@fluke.com

In Europe, Middle East, and Africa:

Eindhoven Calibration Lab
Tel: +31-40-2675300
Email: ServiceDesk@fluke.com

In Asia:

Everett Calibration Lab
Tel: +425-446-6945
Email: service.international@fluke.com

To ensure the accuracy of the Product is maintained at a high level, Fluke Biomedical recommends the product be calibrated at least once every 12 months. Calibration must be done by qualified personnel. Contact your local Fluke Biomedical representative for calibration.

Certification

This instrument was thoroughly tested and inspected. It was found to meet Fluke Biomedical's manufacturing specifications when it was shipped from the factory. Calibration measurements are traceable to the National Institute of Standards and Technology (NIST). Devices for which there are no NIST calibration standards are measured against in-house performance standards using accepted test procedures.

WARNING

Unauthorized user modifications or application beyond the published specifications may result in electrical shock hazards or improper operation. Fluke Biomedical will not be responsible for any injuries sustained due to unauthorized equipment modifications.

Restrictions and Liabilities

Information in this document is subject to change and does not represent a commitment by Fluke Biomedical. Changes made to the information in this document will be incorporated in new editions of the publication. No responsibility is assumed by Fluke Biomedical for the use or reliability of software or equipment that is not supplied by Fluke Biomedical, or by its affiliated dealers.

Manufacturing Location

The ESA615 Electrical Safety Analyzer is manufactured at Fluke Biomedical, 6920 Seaway Blvd., Everett, WA, U.S.A.

Table of Contents

Title	Page
Introduction	1
Intended Use	3
Safety Information	3
Unpack the Product	5
Instrument Familiarization	6
How to Hold the Product	10
How to Connect to Line Power	10
How to Connect a DUT to the Product	11
How to Turn On the Product	11
How to Access the Product Functions	13
How to Connect a PC to the Product	14
How to Set Up the Product	16
Set the Operator Name	16
Delete an Operator Name	17
Set the Date	18

Set the Time.....	18
Set the Test Standard	18
Set the GFCI Limit	18
Set Polarity Switching Delay	19
Set the Date Format.....	19
Set the Time Format	19
Set the Language.....	20
Set the Beeper	20
Set the Display Contrast	20
How to View Instrument Information	20
How to Do Electrical Safety Tests.....	21
Set the Test Standard	21
Mains Voltage Test	21
Ground Wire (Protective Earth) Resistance Test	22
Insulation Resistance Test.....	27
Equipment Current Test.....	33
Leakage Current Test	33
Earth Leakage Current.....	34
Chassis (Enclosure) Leakage Test	37
Lead-to-Ground (Patient) Leakage Test.....	39
Lead-to-Lead (Patient Auxiliary) Leakage Tests	41
Lead Isolation (Mains on Applied Part) MAP Leakage Test.....	43
Alternative Equipment Leakage Test	46
Alternative Applied Part Leakage Test.....	46
Direct Equipment Leakage Test.....	48
Direct Applied Part Leakage Test	50
Differential Leakage Current Test	53
How to Use the 1-to-10 Adapter	55
How to Do Point-To-Point Measurements	59

Measure Voltage	59
Measure Resistance	59
Measure Current.....	60
How to Simulate ECG Waveforms	60
Memory	63
Test Sequences	63
Factory Supplied Test Sequences.....	63
How to Make a Test Sequence.....	66
Make a New Test Sequence.....	66
Make a Test Sequence from a Test Sequence in the Test Library	70
Edit a Test Sequence	70
Do a Test Sequence.....	71
Show Test Results.....	72
Delete a Set of Test Results	73
Maintenance.....	73
Fuse Test and Fuse Replacement.....	73
How to Clean the Product.....	74
Replaceable Parts	75
Accessories.....	77
Specifications	77
Detailed Specifications	79

List of Tables

Table	Title	Page
1.	Symbols.....	2
2.	Top-Panel Controls and Connections.....	7
3.	Side and Top-Panel Connections.....	9
4.	Schematic Abbreviations.....	25
5.	Test Names Based on Selected Standard.....	33
6.	Factory Supplied Test Sequences.....	64
7.	Test Settings for Test Sequences.....	68
8.	Replaceable Parts.....	75
9.	Accessories.....	77

List of Figures

Figure	Title	Page
1.	Front-Panel Controls and Connections	6
2.	Side and Top-Panel Connections.....	8
3.	Product Handle.....	10
4.	Product Ready for Operation.....	11
5.	DUT Connections to the Product.....	12
6.	Leakage Current Menu.....	14
7.	Product to PC Connection.....	15
8.	Setup Menu.....	16
9.	Operator List Screen	16
10.	Mains Voltage Test Menu.....	21
11.	DUT Ground Resistance Measurement.....	23
12.	Ground Wire (Protective Earth) Resistance Measurement Connections.....	24
13.	Ground Wire (Protective Earth) Resistance Measurement Schematic.....	26
14.	Insulation Resistance Measurement	27
15.	Mains to Protective-Earth Insulation Resistance Test Schematic.....	28

16.	Applied Parts to Protective-Earth Insulation Test Schematic.....	29
17.	Mains to Applied-Parts Insulation Test Schematic.....	30
18.	Mains to Non-Earth Accessible Conductive Points Schematic	31
19.	Applied Parts to Non-Earth Conductive Points Schematic.....	32
20.	Leakage Current Main Menu	34
21.	Earth Leakage Current Test Schematic.....	36
22.	Enclosure Leakage Current Test Schematic.....	38
23.	Lead-to-Ground (Patient) Leakage Current Test Schematic.....	40
24.	Applied Parts Connection Posts Display.....	41
25.	Lead-to-Lead (Patient Auxiliary) Leakage Current Test Schematic	42
26.	Lead Isolation (Mains On Applied Parts) Leakage Test Schematic	45
27.	Alternative Equipment Leakage Current Test Schematic.....	47
28.	Alternative Applied Part Leakage Test Schematic	49
29.	Direct Equipment Leakage Test Schematic	51
30.	Direct Applied Parts Leakage Current Test Schematic	52
31.	Differential Leakage Current Test Schematic	54
32.	1-to-10 Adapter Connections	56
33.	ECG Lead Connection with 1-to-10 Adapter.....	58
34.	Point-To-Point Function Menu	59
35.	ECG Waveform Simulation Menu	61
36.	ECG Monitor Connections	62
37.	Input Position ICON	67
38.	Test Sequence Screen	71
39.	Equipment Information Screen	71
40.	Fuse Access	74

Electrical Safety Analyzer

Introduction

⚠⚠ Warning

To prevent possible electrical shock, fire, or personal injury, read all safety information before you use the Product.

The Fluke Biomedical ESA615 Electrical Safety Analyzer (the Product) is a full-featured, compact, portable analyzer, designed to verify the electrical safety of medical devices. The Product tests to domestic (ANSI/AAMI ES1, NFPA 99) and international (IEC62353, AN/NZS 3551, and parts of IEC 60601-1) electrical-safety standards. The Product simulates ECG to do performance tests on ECG monitors.

The integrated ANSI/AAMI ES1 and IEC60601-1 patient loads are easily selectable.





The Product does these tests:





- Line (Mains) voltage
- Ground Wire (Protective Earth) resistance
- Equipment current
- Insulation resistance
- Ground (Earth) leakage
- Chassis (Enclosure) leakage
- Lead to Ground (Patient) and Lead to Lead (Patient Auxiliary) leakage
- Lead isolation (Mains on applied parts leakage)
- Differential leakage

- Direct equipment leakage
- Direct applied part leakage
- Alternative equipment leakage
- Alternative applied part patient leakage
- Point to point leakage, voltage, and resistance
- ECG simulation and performance waveforms

Table 1 is a list of the symbols used on the Product and in this manual.

Table 1. Symbols

Symbol	Description
	WARNING - RISK OF DANGER. Consult user documentation.
	WARNING. HAZARDOUS VOLTAGE. Risk of electric shock.
	Fuse
	Equipotential
CAT II	Measurement Category II is applicable to test and measuring circuits connected directly to utilization points (socket outlets and similar points) of the low-voltage MAINS installation.

Symbol	Description
	Conforms to European Union directives.
	Certified by CSA Group to North American safety standards.
	Conforms to relevant Australian EMC requirements.
	Conforms to relevant South Korean EMC Standards.
	This product complies with the WEEE Directive marking requirements. The affixed label indicates that you must not discard this electrical/electronic product in domestic household waste. Product Category: With reference to the equipment types in the WEEE Directive Annex I, this product is classed as category 9 "Monitoring and Control Instrumentation" product. Do not dispose of this product as unsorted municipal waste.

Intended Use

The Product is an electronic signal source and measurement device for verifying the electrical safety of medical devices. The Product also provides ECG simulation and performance waveforms to verify patient monitors are performing within their operating specifications.

The Product provides the following function categories:

- ECG Functions
- ECG-Performance Testing

The intended user is a trained biomedical equipment technician who performs periodic preventative maintenance checks on patient monitors in service. Users can be associated with hospitals, clinics, original equipment manufacturers and independent service companies that repair and service medical equipment. The end user is an individual, trained in medical instrumentation technology.

This Product is intended to be used in the laboratory environment, outside of the patient care area, and is not intended for use on patients, or to test devices while connected to patients. This Product is not intended to be used to calibrate medical equipment. It is intended for over the counter use.

Safety Information

In this manual, a **Warning** identifies conditions and procedures that are dangerous to the user. A **Caution** identifies conditions and procedures that can cause damage to the Product or the equipment under test.

⚠️⚠️ Warning

To prevent possible electrical shock, fire, or personal injury, follow these guidelines:

- **Carefully read all instructions.**
- **Use the Product only as specified, or the protection supplied by the Product can be compromised.**
- **Use only the mains power cord and connector approved for the voltage and plug configuration in your country and rated for the Product.**
- **Do not apply more than the rated voltage, between the terminals or between each terminal and earth ground.**
- **Measure a known voltage first to make sure that the Product operates correctly.**

- Do not touch voltages >30 V ac rms, 42 V ac peak, or 60 V dc.
- Do not use the Product around explosive gas, vapor, or in damp or wet environments.
- Do not use an extension cord or adapter plug.
- Do not connect the Product to a patient or equipment connected to a patient. The Product is intended for equipment evaluation only. The Product must not be used in diagnostics, treatment, or other capacities where the Product could touch a patient.
- Remove the null post adapter from the \emptyset /Null jack after a test lead zero is performed. The \emptyset /Null jack becomes potentially hazardous during some of the test conditions. Use only cables with correct voltage ratings.
- Keep fingers behind the finger guards on the probes.
- Do not use the 15-20 A adapter to supply power to devices rated more than 15 A. This can overload the installation.
- Use only current probes, test leads, and adapters supplied with the Product.
- Comply with local and national safety codes. Use personal protective equipment (approved rubber gloves, face protection, and flame-resistant clothes) to prevent shock and arc blast injury where hazardous live conductors are exposed.
- Do not touch metal parts of the device under test (DUT) while you do a test. Some tests apply high voltage and high current to the DUT with the DUT earth connection open or closed.
- Examine the case before you use the Product. Look for cracks or missing plastic. Carefully look at the insulation around the terminals.
- Do not use test leads if they are damaged. Examine the test leads for damaged insulation, exposed metal, or if the wear indicator shows. Check test lead continuity.

- **Make sure the ground conductor in the mains power cord is connected to a protective earth ground. Disruption of the protective earth could put voltage on the chassis that could cause death.**
- **Replace the mains power cord if the insulation is damaged or if the insulation shows signs of wear.**
- **Connect the common test lead before the live test lead and remove the live test lead before the common test lead.**
- **Remove all probes, test leads, and accessories that are not necessary for the measurement.**
- **Disable the Product if it is damaged.**
- **Do not use the Product if it is damaged.**
- **Do not use the Product if it operates incorrectly.**
- **Use this Product indoors only.**
- **Use Product-approved measurement category (CAT), voltage, and amperage rated accessories (probes, test leads, and adapters) for all measurements.**

- **Limit operation to the specified measurement category, voltage, or amperage ratings.**
- **Only use probes, test leads, and accessories that have the same measurement category, voltage, and amperage ratings as the Product.**

Unpack the Product

Carefully unpack all items from the box and check that you have these items:

- ESA615
- Getting Started Manual
- Users Manual CD
- Carrying case
- Power cord
- 15 – 20 A Adapter (USA only)
- ESA USA Accessory Kit (USA, Australia, and Israel only) or ESA EUR Accessory Kit
- Ansur Demo CD
- Null Post Adapter
- 5-to-5 Banana to ECG Adapter (BJ2ECG)
- USB Transfer Cable

Instrument Familiarization

Figure 1 and Table 2 show the front-panel controls and connections of the Product.

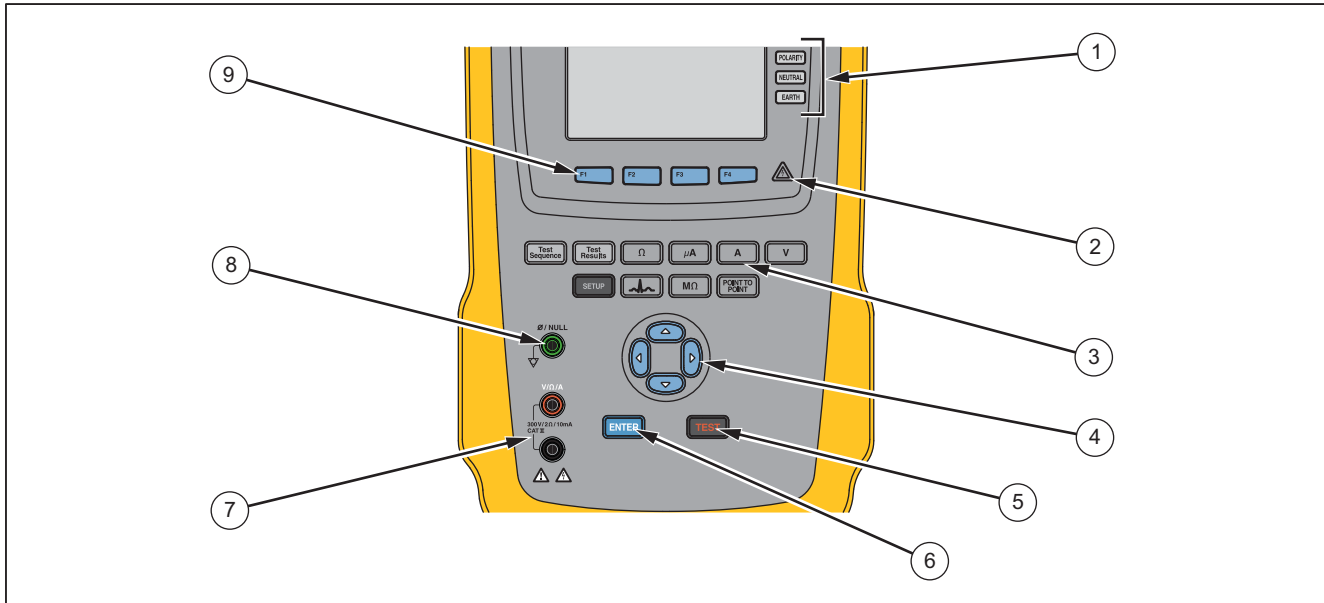

Figure 1. Front-Panel Controls and Connections

gfv116.eps

Table 2. Top-Panel Controls and Connections

Item	Name	Description
①	Equipment Outlet Configuration Buttons	Controls the configuration of the equipment outlet. Opens and closes the neutral and ground connection and reverses the polarity of the neutral and hot connection.
②	High Voltage Indicator	Illuminates when high voltage is applied to the ECG/Applied Parts posts or L1 and L2 of the Test Receptacle.
③	Test Function Buttons	Selects the Product test functions.
④	Navigation Buttons	Cursor control buttons for navigating menus and lists.
⑤	Test Button	Starts selected tests.
⑥	Enter Button	Sets the highlighted function.
⑦	Input Jacks	Test lead connectors.
⑧	Nulling Jack	Connection to zero test lead resistance.
⑨	Function Softkeys	Keys F1 through F4 are used to select from a number of selections that show in the LCD display above each function softkey.

Figure 2 and Table 3 describe the side and top-panel connections of the Product.

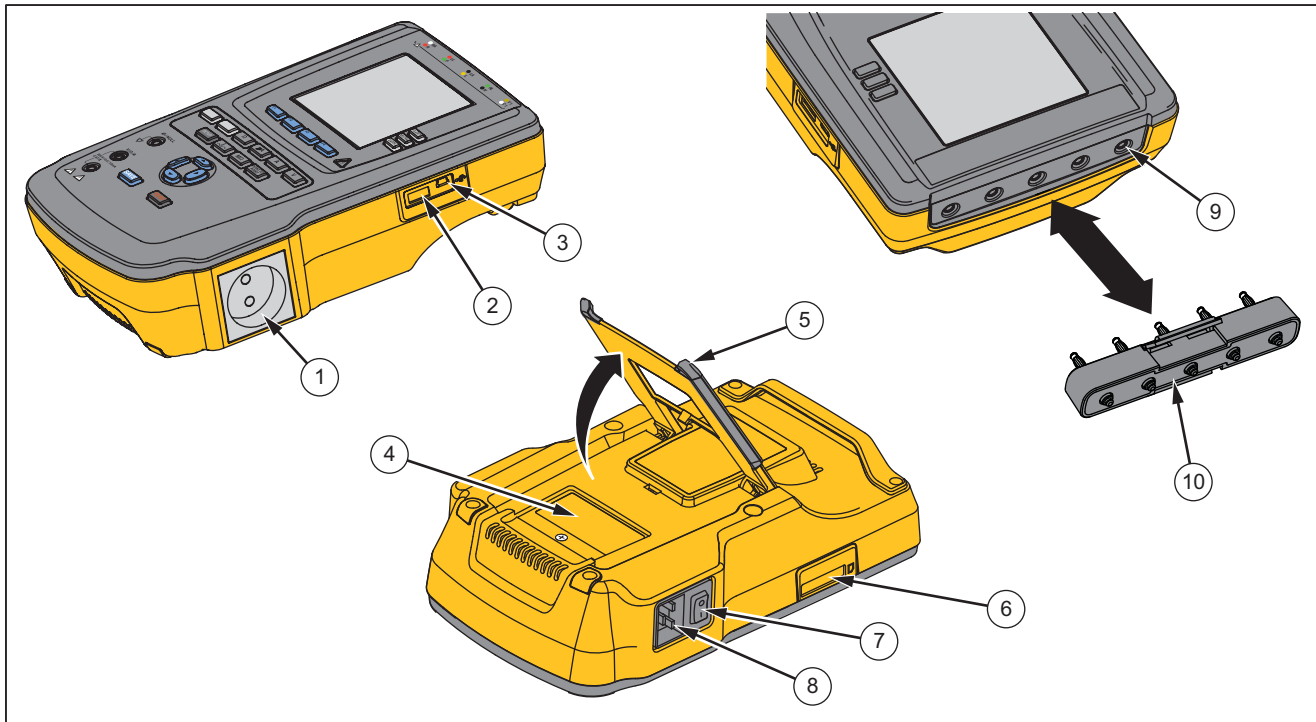

Figure 2. Side and Top-Panel Connections

gtv110.eps

Table 3. Side and Top-Panel Connections

Item	Name	Description
①	Equipment Outlet	Equipment outlet, specified to the version of the Product, which supplies a DUT connection.
②	USB A Controller Port	For external keyboard or barcode reader.
③	USB Device Port (Mini B-style connector)	Digital connection to control the Product from a PC or instrument controller.
④	Fuse Access Door	Equipment outlet fuse access.
⑤	Tilt Stand	Holds the Product in a tilted position.
⑥	SD Card Slot	SD Memory Card access.
⑦	AC Power Switch	Turns ac power on and off.
⑧	Power Input Connector	A grounded male three-prong (IEC 60320 C19) connector that accepts the line-power cord.
⑨	ECG/Applied Parts Jacks	Connection posts for Device Under Test (DUT) applied parts, such as ECG leads. Used to test for leakage current through leads and to supply ECG signals and performance waveforms to a DUT.
⑩	Banana Jack to ECG Adapter	Adapter to connect ECG snap leads to the Product.

How to Hold the Product

When you move the Product, use the handle on the bottom case to hold it. See Figure 3.

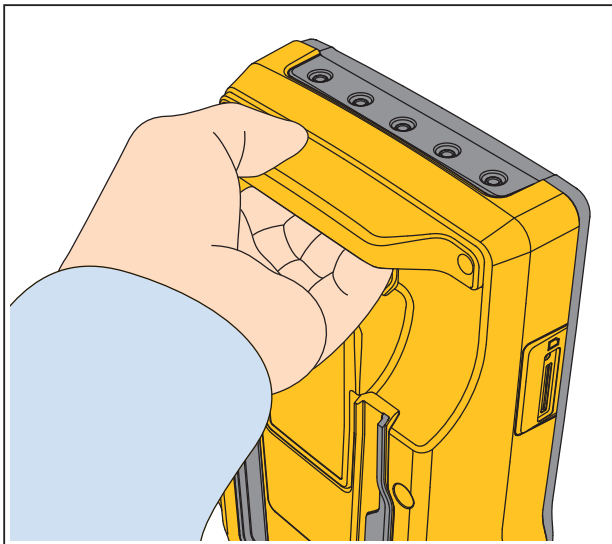

gtv122.eps

Figure 3. Product Handle

How to Connect to Line Power

⚠⚠ Warning

To prevent possible electrical shock, fire, or personal injury:

- Do not use an extension cord or adapter plug.
- Make sure the ground conductor in the mains power cord is connected to a protective earth ground. Disruption of the protective earth could put voltage on the chassis that could cause death.
- Replace the mains power cord if the insulation is damaged or if the insulation shows signs of wear.
- Use only the mains power cord and connector approved for the voltage and plug configuration in your country and rated for the Product.
- Do not put the Product where access to the mains power cord is blocked.

The Product is intended for use with single-phase, grounded power. It is not intended for dual, split-phase or three-phase power configurations. It can be used with a power system that supplies the correct voltages for single-phase and is grounded, or is an isolated power system.

Use the power cord for your country mains supply that is not more than the voltage or power rating of the product. Connect the cord into the power input connector and then to the mains outlet.

How to Connect a DUT to the Product

You can connect a Device Under Test (DUT) a number of different ways for a full electrical safety test. Figure 5 shows a DUT connected to the test receptacle, applied parts posts, and a connection to the enclosure or protective earth ground of the DUT.

⚠⚠ Warning

To prevent possible electrical shock, fire, or personal injury:

- **Use Product-approved measurement category (CAT), voltage, and amperage rated accessories (probes, test leads, and adapters) for all measurements.**

- **Do not put metal objects into connectors.**
- **Do not use exposed metal BNC or banana plug connectors.**

How to Turn On the Product

Note

To make sure the high voltage indicator works, look for it to illuminate at the power-up.

Push the power switch found on the left-side panel so the “I” side of the ac power switch is down. The Product does a series of self tests and then shows the message in Figure 4 when the self test has completed successfully.

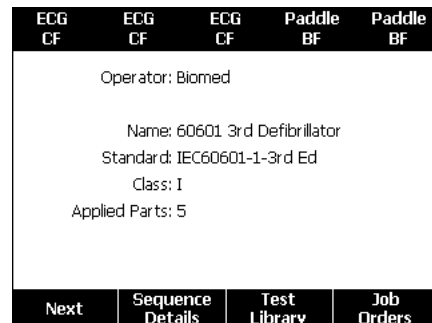

gtv125.bmp

Figure 4. Product Ready for Operation

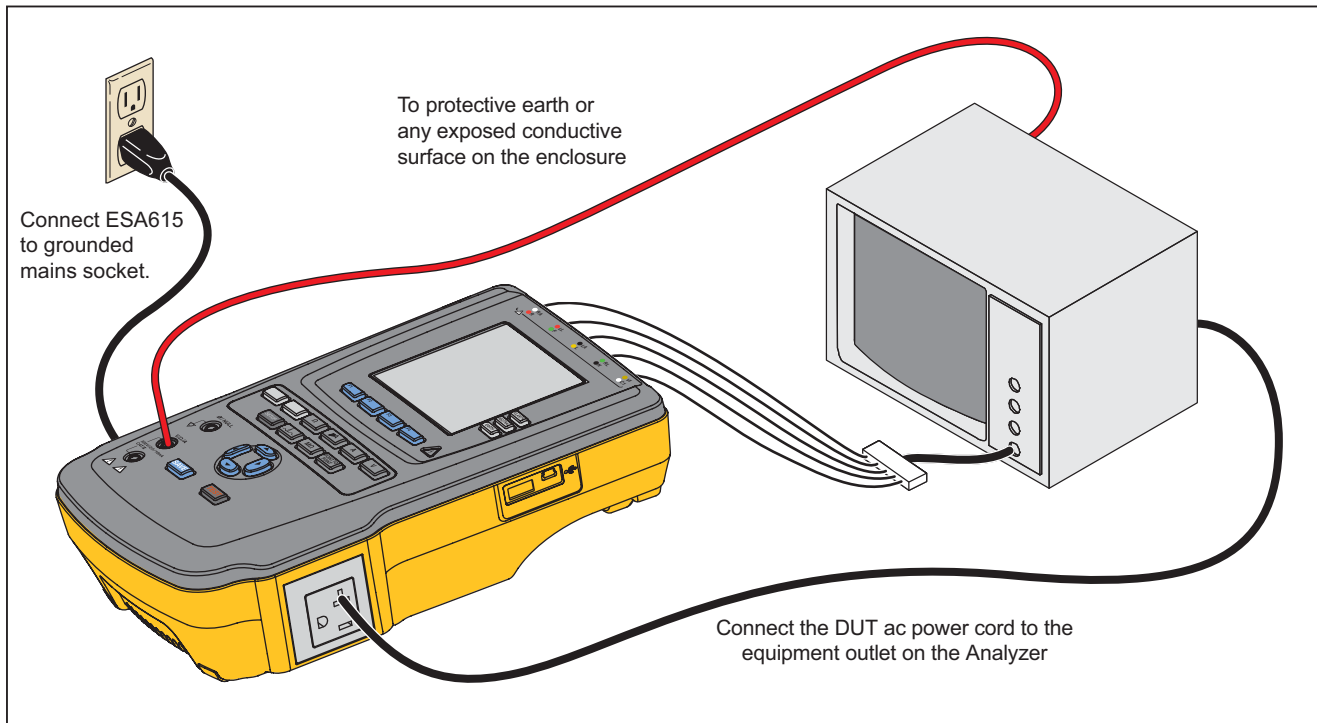







gtv113.eps

Figure 5. DUT Connections to the Product

The self-test measures the ac mains input for correct polarity, ground integrity and voltage level. The high voltage indicator illuminates briefly during the self test. If the polarity is reversed, the Product shows this condition and sets the polarity to be reversed internally. If the ground is open, the Product shows this fault. If the mains voltage is too high or too low, the Product shows this fault and does not continue until the supply voltage is corrected and the Product power turned off and then on again.

How to Access the Product Functions

For each test and setup function, the Product uses a series of menus to access different Product tests and setup variables. The example shown in Figure 6, the Product shows different leakage current tests along the bottom of the display. The **More** softkey lets you access more menus related to the test. When you push a softkey (**F1** through **F4**) below a test name, the Product sets up for or does the selected test.

For some tests, it will be necessary to set parameters with the navigation buttons. In the example above, the leakage parameter has  next to it. This icon shows you must push  or  to set its value. In this example, the leakage current measurement changes between AC+DC, AC only, or DC only. The applied parts indicator has  on the left end and  on the right end. These icons show that you must push  and  to set an applied part.

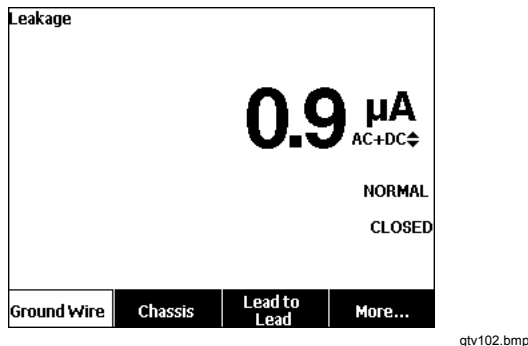

Figure 6. Leakage Current Menu

The three buttons along the right side of the display (POLARITY NEUTRAL EARTH) control the wiring of the Product's test receptacle for some electrical tests. The current condition of these three buttons is shown along the right edge of the display when these controls are active.

Figure 5 shows polarity is settable between normal, reversed, and off. Neutral is also settable to closed or open. Earth condition is not shown, which means it can not be changed. Earth is internally opened while the Product does this test.

How to Connect a PC to the Product

To connect the Product to a PC:

Connect a USB port on your PC or laptop to the Mini B USB device port on the Product.

Or

Plug in an XStick wireless USB dongle to your PC USB port. Products available over wireless will be listed by serial number. Connect to a single Product. See Figure 7.

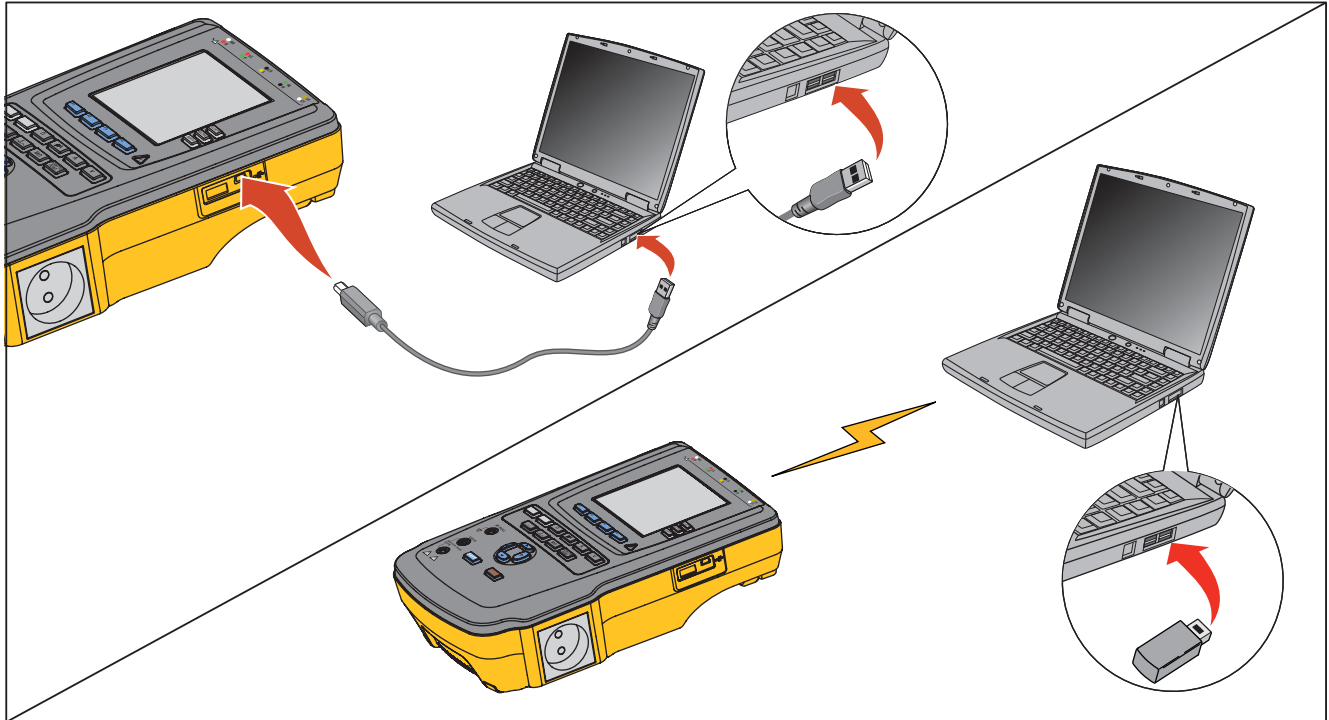

Figure 7. Product to PC Connection

gtv129.bmp

How to Set Up the Product

There are a number of Product parameters that are adjusted through the setup function. To access the first Setup menu shown in Figure 8, push **SETUP**.

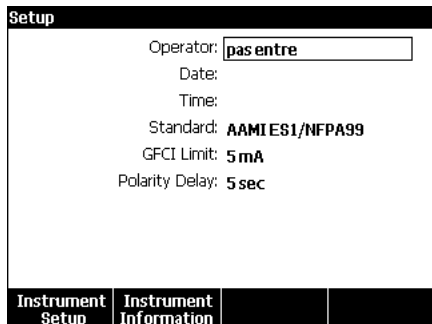

Figure 8. Setup Menu

gtv124.bmp

Set the Operator Name

You can associate an operators name with electrical test results. To set the operator name:

1. From the Setup menu, push **▲** or **▼** until the **Operator** name is highlighted.
2. Push **ENTER**.

An operator list shows in the display. See Figure 9. The **Default User** name "None" is used when an actual user name is not set.

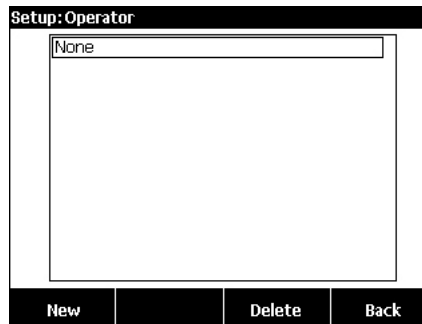

gtv123.jpg

Figure 9. Operator List Screen

Set the Operator Name from a List

1. From the Operator list, push **▲** or **▼** to highlight one of the operator names.
2. Push **ENTER**.

Set a New Operator Name

1. From the Operator list, push the **New** softkey.

Note

*The Product keeps a maximum of 20 operator names. If you push the **New** softkey and there are already 20 names, the Product will show an error. You will have to delete one or more names to add a new name.*

2. In the Keyboard screen, push **⏪**, **⏩**, **⏴**, or **⏵** to move the highlight to a character.
3. Push **ENTER** to add the highlighted character to the name field.

Note

*You can push the **F2** softkey to set the keyboard between upper and lower case letters. Highlight àéïöç and push **ENTER** to toggle between accent characters and standard alpha-numeric letters.*

4. Do steps 2 and 3 again until the operator name is complete.
5. Push the **Done** softkey.

Note

*Push the **Back** softkey to delete the last character in the name field.*

Delete an Operator Name

To delete an operator name:

1. From the Setup menu, push **⏴** or **⏵** until the **Operator** name is highlighted.
2. Push **ENTER**.
3. From the Operator list, push **⏴** or **⏵** to highlight one of the operator names.
4. Push the **Delete** softkey.
5. A delete confirmation screen will show in the display.
6. Push the **Delete** softkey.

Set the Date







From the Setup menu, push **⏴** or **⏵** until the **Date** value is highlighted.

1. Push **ENTER**.
2. In the Keyboard screen, push **⏪** or **⏩** to move the highlight to a character.
3. Push **ENTER**.
4. Do steps 2 and 3 again until the date is complete.
5. Push the **Done** softkey.

Note

*Push the **Back** softkey to delete the last character in the date field.*

Set the Time

1. From the Setup menu, push  or  until the **Time** value is highlighted.
2. Push .
3. In the Keyboard screen, push  or  to move the highlight to a character.
4. Push .
5. Do steps 3 and 4 again until the time is complete.

Note







*When you set the time for 12-hour format, push the **am/pm** softkey to set AM or PM.*

6. Push the **Done** softkey.

Note

*Push the **Back** softkey to delete the last character in the date field.*

Set the Test Standard



1. From the Setup menu, push  or  until the **Standard** variable is highlighted.
2. Push .
3. Push  or  to highlight one of the standards.
4. Push .

Set the GFCI Limit

The GFCI (Ground Fault Current Interrupter) protects the DUT from short circuits when it is connected to the test receptacle of the Analyzer. (The GFCI has no effect during Insulation testing, Protective Earth Resistance testing, and Voltage testing because the test receptacle is not connected to mains power for these tests.) When the GFCI trips, it removes power from the test receptacle, and also the DUT, by opening the relays. The Analyzer continues to operate and shows "Fault Detected" with an explanation.







The Analyzer uses the GFCI setting for the standard the user selected for testing. For best results, verify the GFCI setting in the Setup menu. The AAMI standard specifies 5 mA. All of the other standards (for example IEC 60601-1 and IEC 62353) specify 10 mA. The 25 mA setting is a special case that is not defined in any standard.

To set the GFCI current limit:







1. From the Setup menu, press the softkey labeled **Instrument Setup**, to show the instrument setup selections.
2. Press the softkey labeled **More** to show additional menu selections.
3. Press the softkey labeled **GFCI Limit** to open a scroll box above the softkey label.
4. Press  or  to adjust the current limit.
5. Press the softkey labeled **GFCI Limit** to exit the GFCI Limit setup function.

Set Polarity Switching Delay







When the test receptacle of the Product is switched, a delay can be set to control the actual switch time. To set the polarity delay:

1. From the Setup menu, push  or  until the **Polarity Delay** variable is highlighted.
2. Push .
3. Push  or  to highlight one of the preset delay values.
4. Push .

Set the Date Format







1. From the Setup menu, push the **Instrument Setup** softkey.
2. Push  or  until the **Date Format** variable is highlighted.
3. Push .
4. Push  or  to highlight **DD/MM/YYYY**, **MM/DD/YYYY**, or **YYYY/MM/DD**.
5. Push .

Set the Time Format

1. From the Setup menu, push the **Instrument Setup** softkey.
2. Push  or  until the **Time Format** variable is highlighted.
3. Push .
4. Push  or  to highlight **12 Hour** or **24 Hour**.
5. Push .







Set the Language

The Product can display data in English, French, German, Spanish, Italian, or Portuguese. To change the language:

1. From the Setup menu, push the **Instrument Setup** softkey.
2. Push  or  until the **Language** variable is highlighted.
3. Push .
4. Push  or  to highlight one of the languages.
5. Push .



Set the Beeper

To enable or disable the beeper:



1. From the Setup menu, push the **Instrument Setup** softkey.
2. Push  or  until the **Beeper** variable is highlighted.
3. Push .
4. Push  or  to highlight **Off** or **On**.
5. Push .

Set the Display Contrast

There are two procedures to set the display contrast. From the Test Sequence start-up menu or through the Setup menu.

When the Product shows its Start-Up menu (Select a test...), push  or  to increase or decrease the display contrast respectively. Push the **Done** softkey to exit contrast setup.

To adjust the contrast through the Setup menu:

1. From the Setup menu, push the **Instrument Setup** softkey.
2. Push the **Display Contrast** softkey.
3. Push  or  to increase or decrease the display contrast respectively.
4. Push the **Done** softkey to exit contrast setup.

How to View Instrument Information

To show model number, serial number, firmware version, and last calibration date of the Product, push **SETUP**. Next push the **Instrument Information** softkey.

How to Do Electrical Safety Tests

The Product does a number of different electrical and performance tests on biomedical equipment. The sections that follow are test descriptions with instructions on how to do them with the Product.

Set the Test Standard

The electrical safety tests in the Product are specified by different safety standards: AAMI ES1/NFPA99, IEC62353, IEC60601-1, and AN/NZS 3551. AAMI is set as the default standard. To select different standard:

1. From the Setup menu, push **↵** until the **Standard** variable is highlighted.
2. Push **ENTER**.
3. Push **↶** or **↷** to highlight one of the standards.
4. Push **ENTER**.

Not all electrical tests are applicable for all standards. In these cases, the menu only shows the tests that are specified in the set standard.

Note

The standard set in the Setup menu applies to all manual measurement modes. The automated tests use the standard set for the selected test sequence.

Mains Voltage Test

The Mains Voltage test measures the voltage on the mains input through three measurements. To access the Mains Voltage test, push **V**. The Mains Voltage test menu is shown in Figure 10.

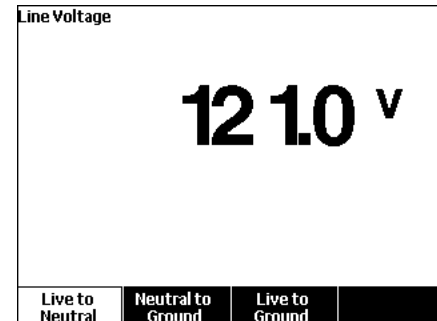

glv104.bmp

Figure 10. Mains Voltage Test Menu

Push each function softkey to do each of the three measurements: Live to neutral, neutral to ground, and live to ground.

Note

Power is removed from the test receptacle while the Product does a Mains Voltage test.

Ground Wire (Protective Earth) Resistance Test

The Ground Wire (Protective Earth) Resistance test measures the impedance between the PE terminal of the test receptacle and the exposed conductive parts of the DUT that are connected to the Protective Earth of the DUT.

Note

Before you do leakage tests with the Product, it is best to make sure the ground connection is good.

Do this test between the test receptacle ground and the Protective earth ground of the DUT or DUT enclosure.

To access the Ground Wire (Protective Earth) \emptyset /Null Resistance Test menu push $\boxed{\Omega}$.

Note

The DUT is turned off for this test.

To do a ground wire resistance test:

1. Make sure the power cord from the DUT is connected into the test receptacle.
2. Push $\boxed{\Omega}$ to reveal the resistance function menu.
3. Connect one end of a test lead to the V/ Ω /A jack. See Figure 12.
4. If you use an accessories probe, connect it to the other end of the test lead and put the probe tip into the \emptyset /Null jack. If you use an alligator clip accessory, connect it to the other end of the test lead, put the null post adapter in the \emptyset /Null jack, and clamp the alligator clip to the null post adapter.

Note

The \emptyset /Null jack does not accept the test leads supplied with the Product.

5. Push the **Zero Leads** softkey. The Product zeroes out the measurement to cancel the test lead resistance.
6. Connect the test lead from the V/ Ω /A jack to the DUT enclosure or protective earth connection.
7. After you make the connections to the DUT, the measured resistance shows in the display. See Figure 11.



gtv105.jpg

Figure 11. DUT Ground Resistance Measurement

For Products shipped with a US outlet:

As a temporary deviation, this unit includes a 15 A to 20 A adapter. Use the adapter to accommodate devices with 20 A power plugs. When this adapter is installed, use the included ground lug and zero out the resistance for Ground Wire (Protective Earth) Resistance measurements. If you do not zero the resistance, you must add an additional factor of 5 mΩ to the readings obtained in Ground Wire Resistance mode.

To zero the resistance for units with the adapter, connect the adapter to the test receptacle. Follow the procedure above, and replace step 4 with:

4. If using a probe accessory, connect it to the other end of the test lead and place the probe tip into the ground jack on the 15 A-to-20 A adapter. If using an alligator clip accessory, connect it to the other end of the test lead, place the null post adapter in the ground jack of the 15 A-to-20 A adapter, and clamp the alligator clip to the null post adapter.

⚠️ Warning

To prevent electrical shock, remove the null post adapter from the Ø/Null jack after a test lead zero is performed. The Ø/Null jack becomes potentially hazardous during some of the test conditions.

A low resistance measurement is necessary to make sure there is a good ground connection through the power cord. Refer to the applicable electrical safety standard for the specified limit value to be followed.

Figure 13 shows the electrical connections between the Product and the DUT. Table 4 is a list of the abbreviations used in the schematics and their descriptions.

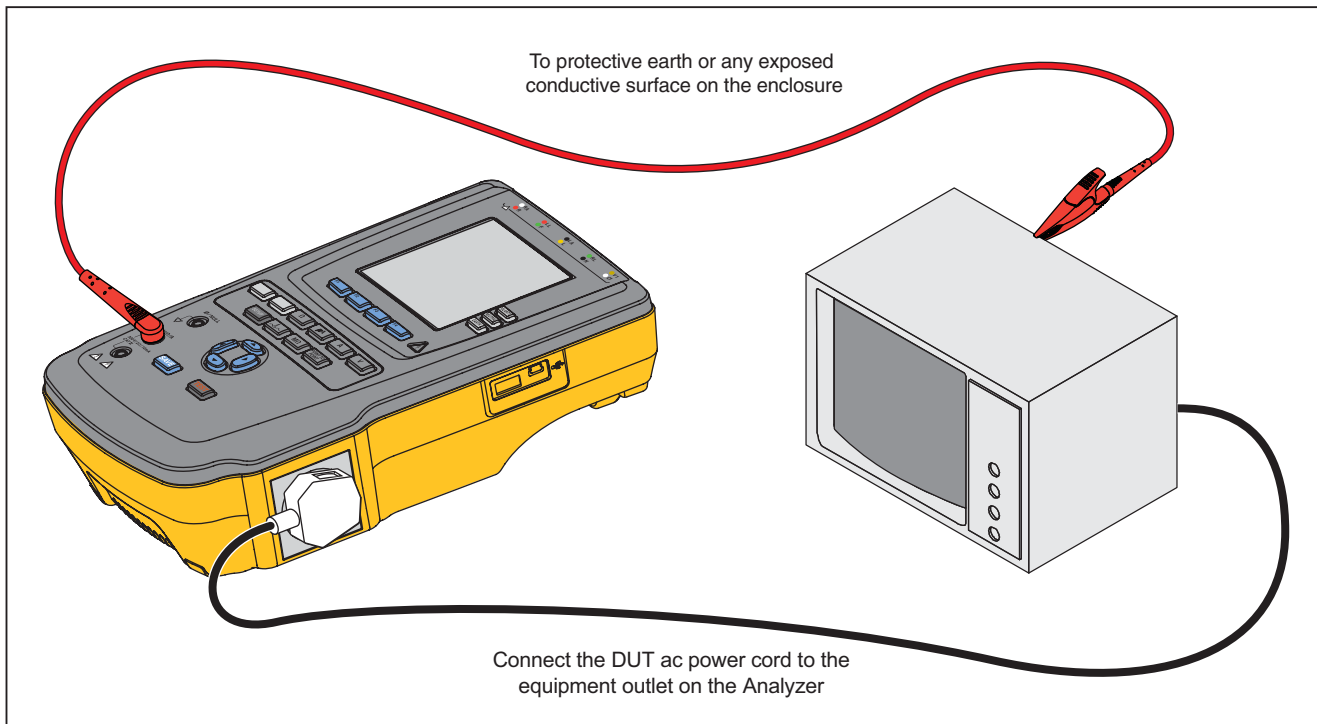

gtv112.eps

Figure 12. Ground Wire (Protective Earth) Resistance Measurement Connections

Table 4. Schematic Abbreviations

Abbreviation	Meaning
MD	Measurement Device (ESA615 Analyzer)
FE	Functional Earth
PE	Protective Earth
Mains	Mains voltage supply
L1	Live conductor
L2	Neutral conductor
DUT	Device Under Test
DUT_L1	Device Under Test live conductor
DUT_L2	Device Under Test neutral conductor
DUT_PE	Device Under Test Protective Earth
REV POL	Reversed mains supply polarity
LEAD GND	Lead to ground, used in patient leakage test
MAP	Mains on Applied Part
MAP REV	Reverse Mains on Applied Part source voltage
PE Open	Open Protective Earth
	Test voltage

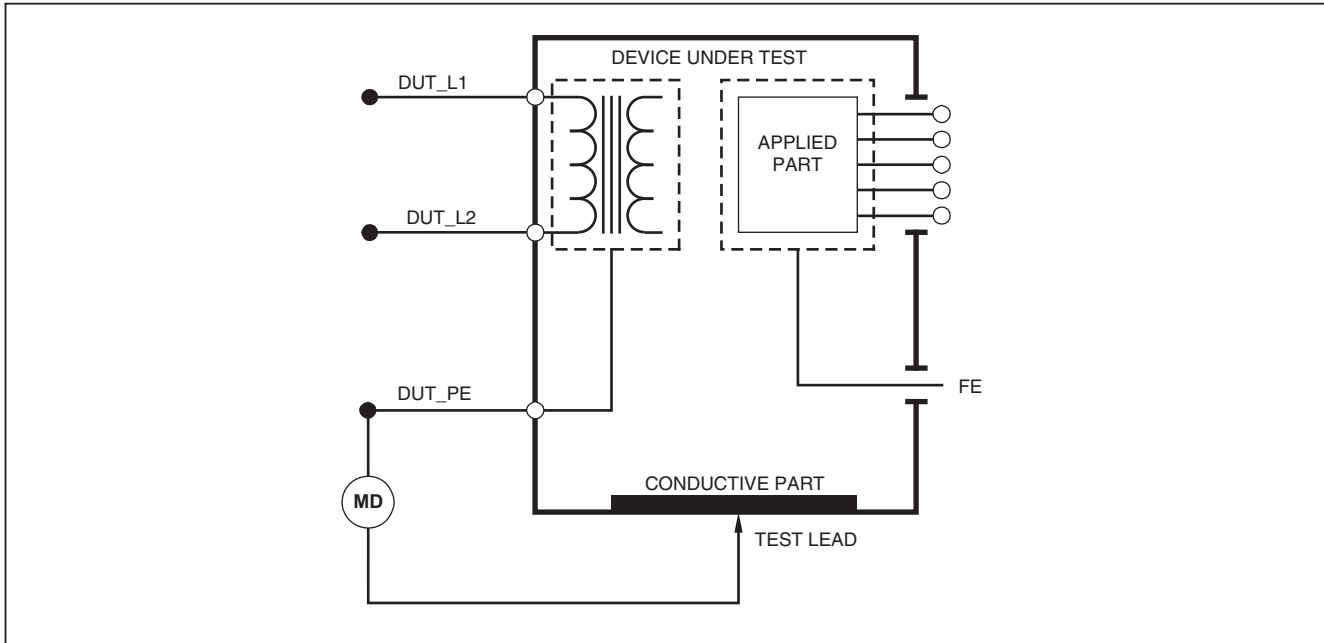

faw26.eps

Figure 13. Ground Wire (Protective Earth) Resistance Measurement Schematic

Insulation Resistance Test

The five Insulation Resistance Tests measure mains (L1 and L2) to Protective earth, applied parts to Protective earth, mains to applied parts, mains to non-earthed conductive points, and applied parts to non-earthed conductive points.

To access the Insulation Resistance Test menu, push **MΩ**.

All Insulation Resistance Tests can be done with 500 V dc or 250 V dc. To change the test voltage from the Insulation Resistance Test menu, push the **More** softkey. Push the **Change Voltage** softkey to toggle the test voltage between 250 V dc and 500 V dc.

Note

When you exit and re-enter the Insulation Resistance Test menu, the test voltage is set to its default value of 500 V dc.

As shown in Figure 14, three of the five tests are shown above function softkeys **F1** through **F3**. To access the other two tests or test voltage selection, push the **More** softkey. The **Back** softkey will move the menu up to the top-level Insulation Resistance test menu.

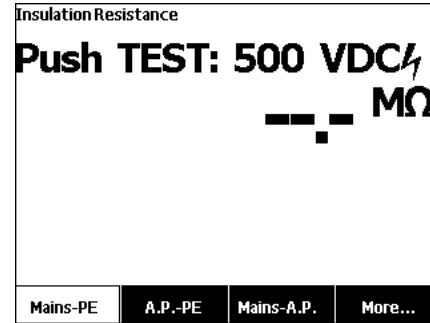

gtv106.jpg

Figure 14. Insulation Resistance Measurement

After you push a test softkey, push **TEST** to apply the test voltage to the DUT and take the resistance measurement.

Figures 15 through 19 shows the electrical connections between the Product and DUT for the five Insulation Resistance tests.

Note

The DUT is powered off for this test.

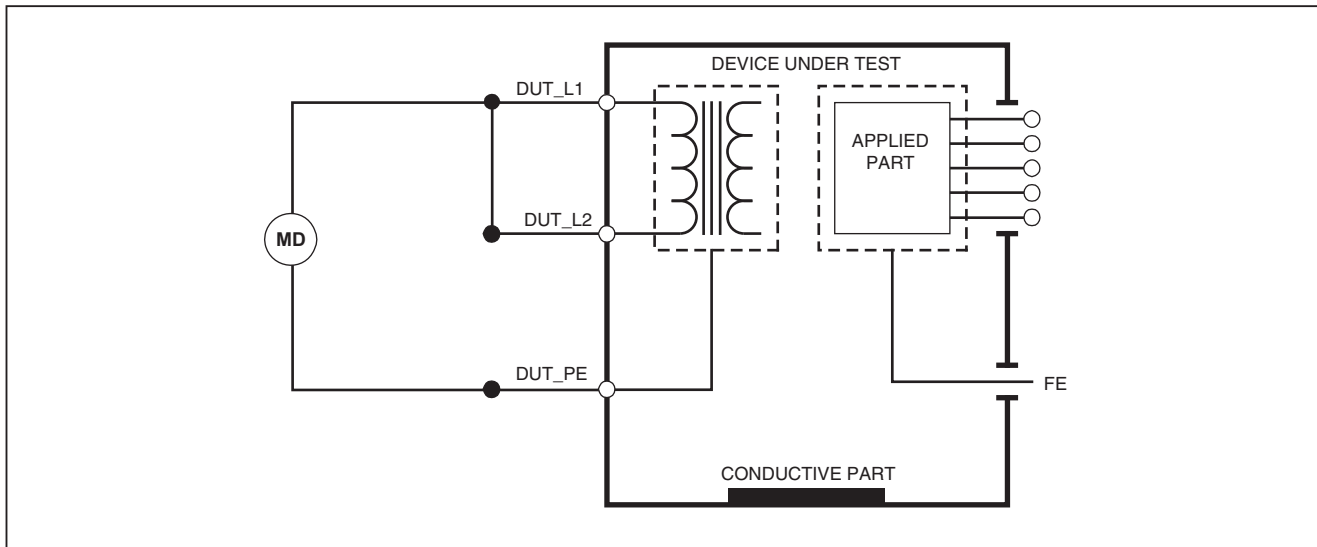

faw17.eps

Figure 15. Mains to Protective-Earth Insulation Resistance Test Schematic

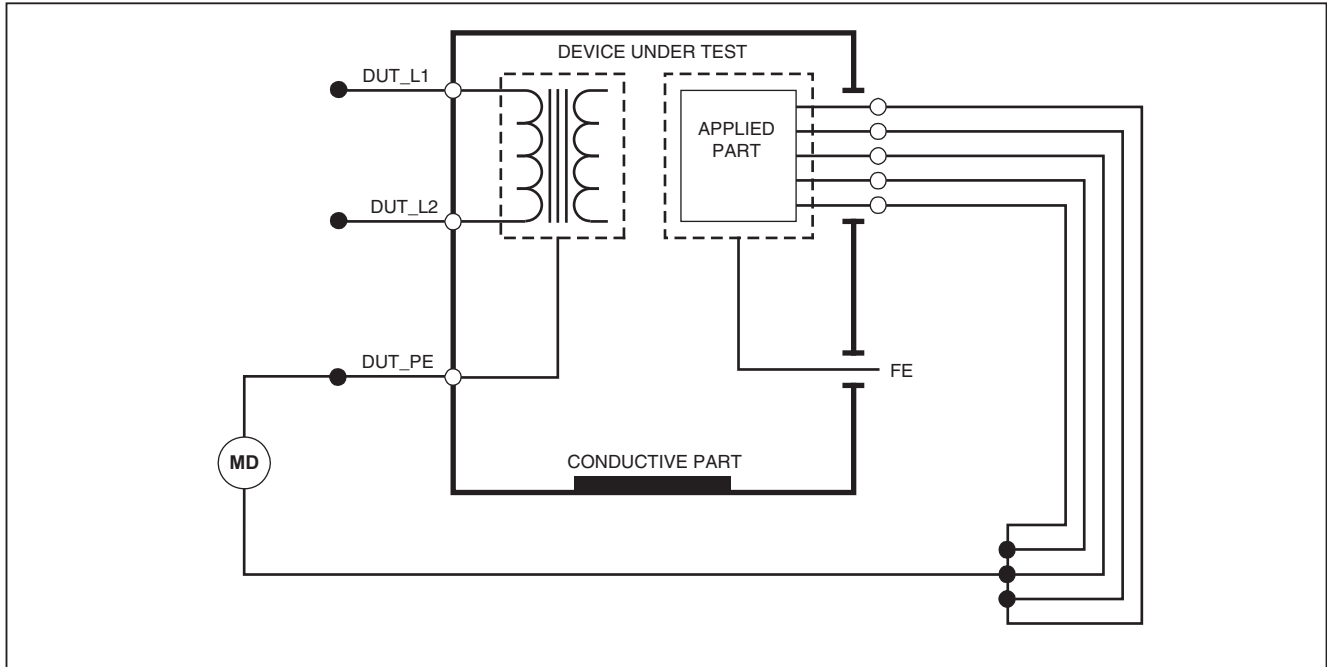

faw18.eps

Figure 16. Applied Parts to Protective-Earth Insulation Test Schematic

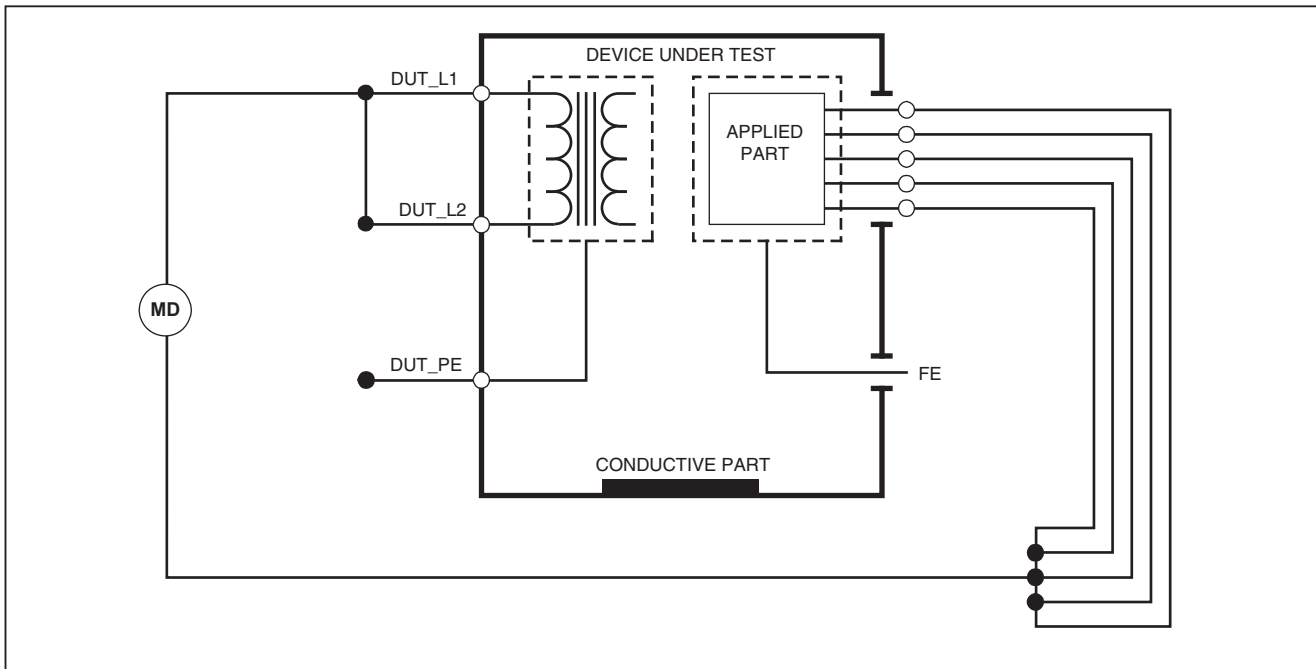

faw19.eps

Figure 17. Mains to Applied-Parts Insulation Test Schematic

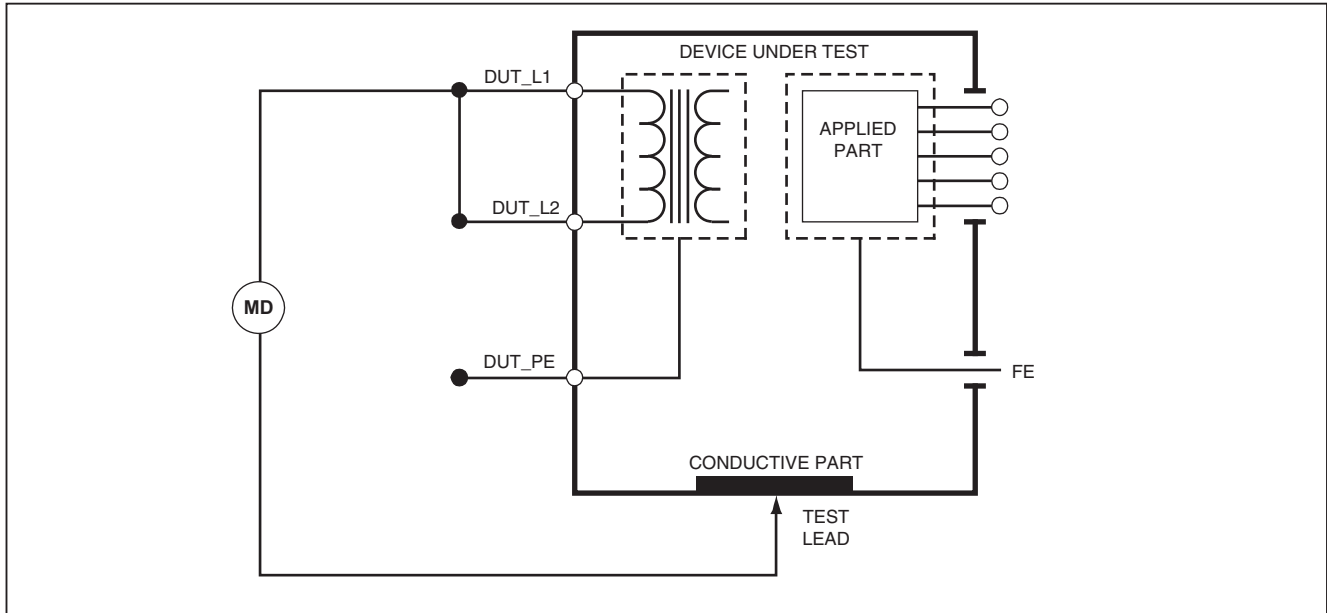

faw20.eps

Figure 18. Mains to Non-Earth Accessible Conductive Points Schematic

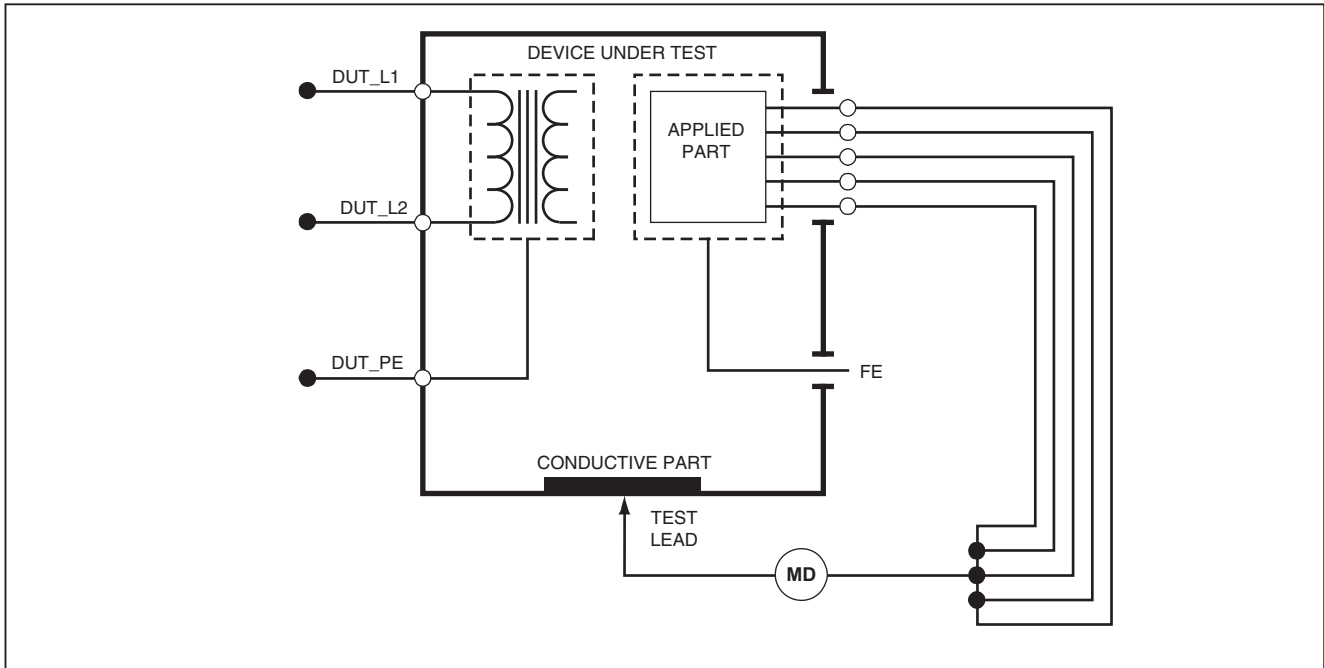

faw21.eps

Figure 19. Applied Parts to Non-Earth Conductive Points Schematic

Equipment Current Test

To measure the current consumed by the DUT, push **A**. The Product shows the current that flows through the mains connections of the test receptacle.

Leakage Current Test

The Product measures leakage current for different DUT configurations. The Product measures leakage found on the enclosure and the earth connection as well as leakage on each connected applied part and combinations of connected applied parts.

The available leakage tests are set by the standard you set in setup. See the How to Set the Test Standard section to change the test standard.

Table 5 is a list of six leakage current tests. Their names are different when the standard is changed in the Product.

Push **μA** to access the Leakage Current main menu shown in Figure 20.

Table 5. Test Names Based on Selected Standard

IEC60601	AAMI/NFPA 99
Protective Earth Resistance	Ground Wire Resistance
Earth Leakage Current	Ground Wire Leakage Current
Touch or Enclosure Leakage Current	Chassis Leakage Current
Patient Leakage Current	Lead to Ground Leakage Current
Patient Auxiliary Leakage Current	Lead to Lead Leakage Current
Mains on Applied Part (MAP) Leakage Current	Isolation Leakage Current

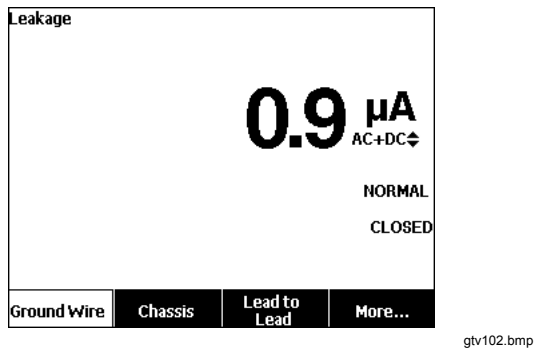

Figure 20. Leakage Current Main Menu

Note

The display shown in Figure 20 is the main Leakage Current menu when AAMI is the standard.

All leakage currents but Lead Isolation (Mains on Applied parts), are shown in as AC+DC, AC Only, or DC only. The initial result is shown in the applicable parameter for the set test standard. To change the parameter, push \blacktriangle or \blacktriangledown . The measurement method is shown to the right of the current measurement while leakage current tests are done.

Earth Leakage Current

Note



The Ground Wire (Earth) Leakage test is available for AAMI, 60601, and not IEC 62353.

To measure the current that flows in the protective earth circuit of the DUT, push the **Ground Wire** softkey from the Leakage Current main menu. Figure 21 shows the electrical connections between the Product and the DUT when you do a Ground Wire Leakage Current Test.

The Ground Wire Leakage Current test has some combination measurements that can be done. Push **POLARITY** to switch the polarity of the mains voltage applied to the test receptacle between Normal, Off, Reverse, and Off. Push **NEUTRAL** to open and close the neutral connection to the test receptacle. It is not necessary to open up the test receptacle earth (ground), since this is done internally by the measurement.

The outlet conditions below apply when you do this test:

- Normal Polarity
- Normal Polarity, Open Neutral
- Reversed Polarity
- Reversed Polarity, Open Neutral

IEC60601-1 specifies that the applied parts must be connected for this measurement. Push  or  to ground and unground all applied parts connection posts.

Note

A ground connection on an applied part is shown as a box around the applied part in the display.

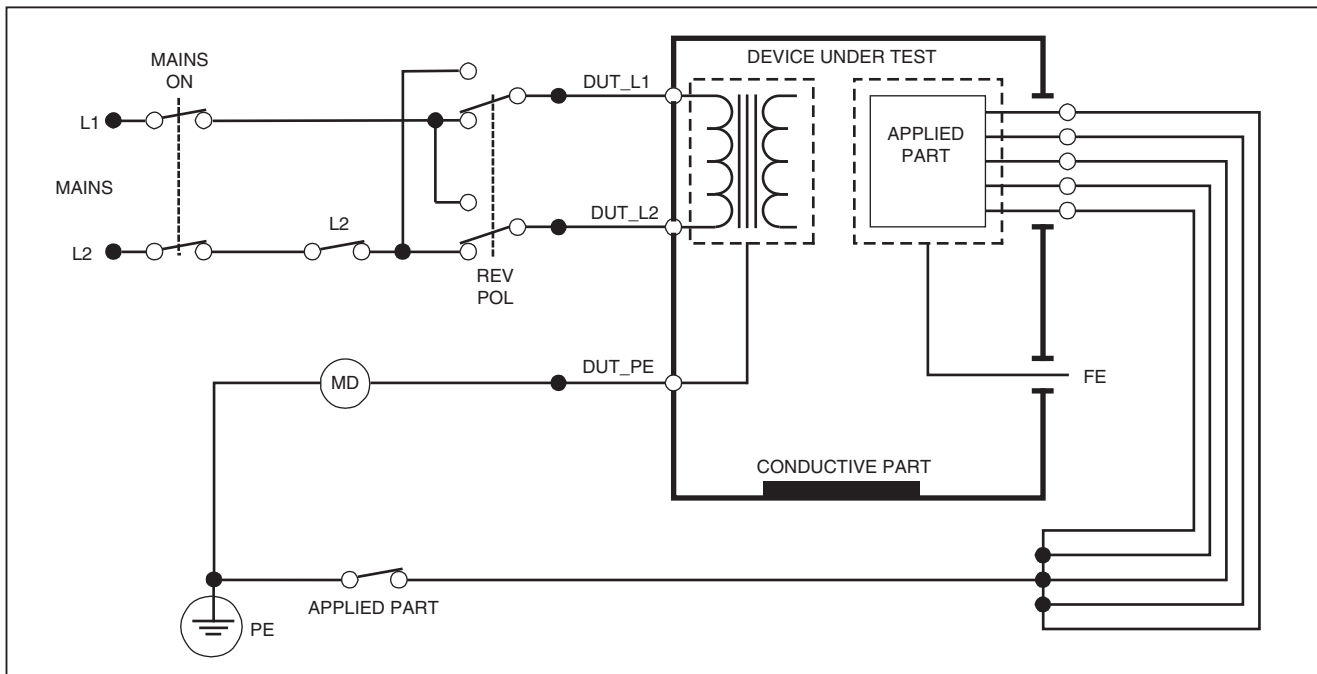

faw27.eps

Figure 21. Earth Leakage Current Test Schematic

Note

Ground wire leakage is the same schematic without the Applied Parts switch.

Chassis (Enclosure) Leakage Test

Note

The Chassis (Enclosure) Leakage test is only available for the IEC60601 or ANSI/AAMI ES1 1993 standard selections.

The Chassis (Enclosure) Leakage Test measures the current that flows between the enclosure of the DUT and protective earth. Figure 22 shows the electrical connections between the Product and the DUT.

To do a Chassis (Enclosure) Leakage Test:

1. Connect a lead between the V/ Ω /A jack and the DUT enclosure.
2. Push **μ A**.
3. Push the **Chassis** softkey from the Leakage Current Test menu.
4. The measured current shows in the display.

The Chassis Leakage test can be done with different fault conditions on the test receptacle. Push **POLARITY** to switch the test receptacle between Normal, Off, Reverse, and Off. Push **NEUTRAL** to open and close the neutral connection to the receptacle. Push **EARTH** to open and close the earth connection of the receptacle.

The outlet conditions below apply when do this test:

- Normal Polarity
- Normal Polarity, Open Earth
- Normal Polarity, Open Neutral
- Reversed Polarity
- Reversed Polarity, Open Earth
- Reversed Polarity, Open Neutral

IEC60601-1 specifies that the applied parts must be connected for this measurement. Push **⏏** or **⏑** to ground and unground all applied parts connection posts.

Note

Chassis leakage for ANSI/AAMI is the same schematic without the Applied Parts switch.

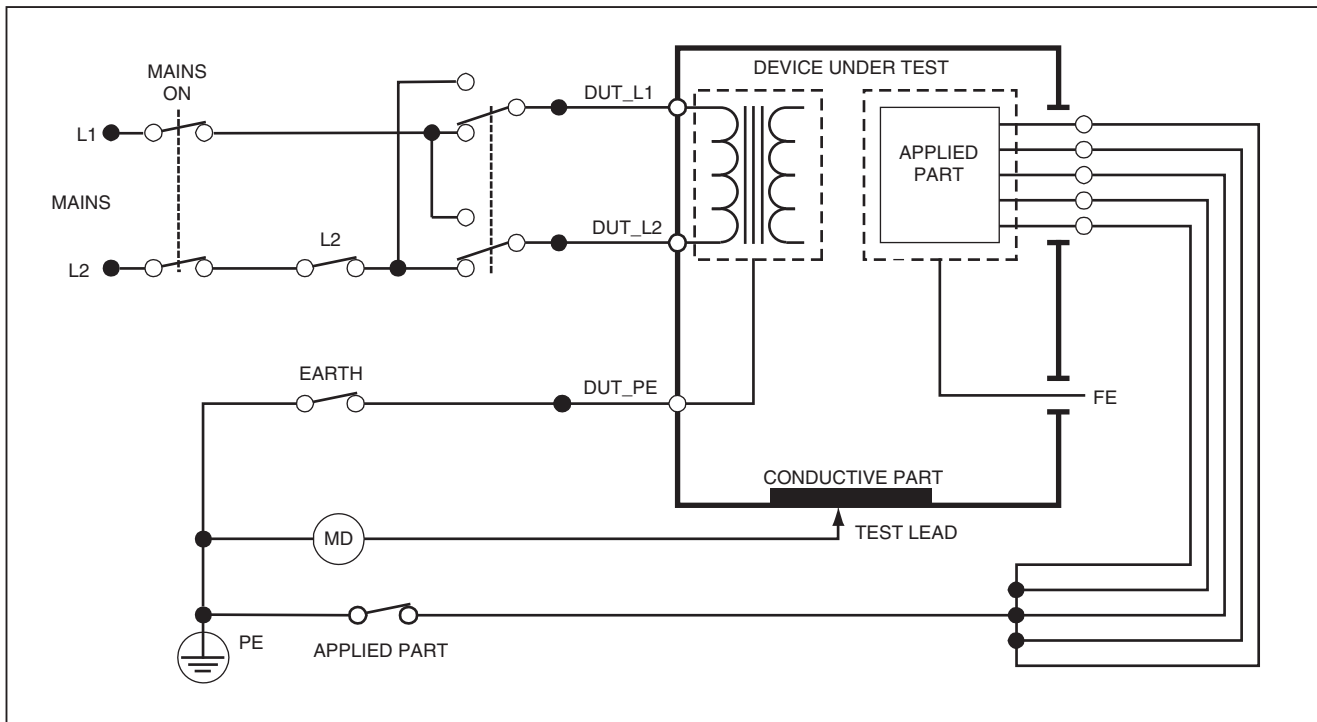

faw28.eps

Figure 22. Enclosure Leakage Current Test Schematic

Lead-to-Ground (Patient) Leakage Test

Note

The Lead-to-Ground (Patient) Leakage Current Test is not available for IEC 62353 standard selections.

The Lead-to-Ground (Patient) Leakage Current test measures the current that flows between in one applied part, a group of applied parts, or all applied parts, and the Mains PE. Figure 23 shows the electrical connections between the Product and the DUT.

To do a Lead-to Ground (Patient) leakage test:

1. Push **[μ A]**.
2. Push the **More** softkey.
3. Push **▲** or **▼** to set one of the applied part groupings.

Note

Refer to the test standard when you know the type of the applied parts and how they must be grouped for the test.

4. Push the **Select** softkey.
5. Push **⏪** or **⏩** to advance through each applied part grouping, or the individual applied parts, to ground. These are selected and measured.

The Lead-to-Ground Leakage test can be done with different fault conditions on the test receptacle. Push **[POLARITY]** to switch the test receptacle between Normal, Off, Reverse, and Off. Push **[NEUTRAL]** to open and close the neutral connection to the receptacle. Push **[EARTH]** to open and close the earth connection in the receptacle.

The outlet conditions below apply when you do this test:

- Normal Polarity
- Normal Polarity, Open Neutral
- Normal Polarity, Open Earth
- Reversed Polarity
- Reversed Polarity, Open Neutral
- Reversed Polarity, Open Earth

Note

If there are more than five applied parts to connect to the Product, see the How to Use the 1-to-10 Adapter section in this manual.

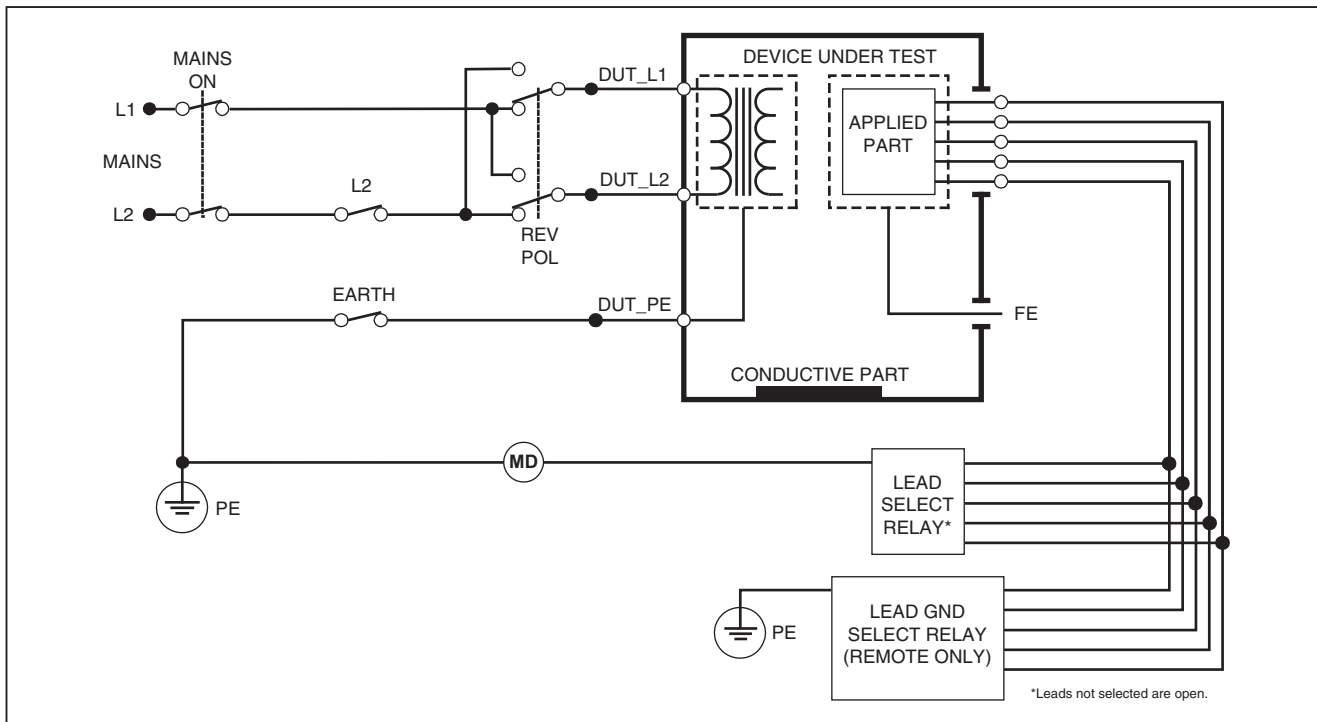

Figure 23. Lead-to-Ground (Patient) Leakage Current Test Schematic

gtv29.eps

Lead-to-Lead (Patient Auxiliary) Leakage Tests

Note

The Lead-to-Lead (Patient Auxiliary) leakage test is available when the IEC60601 or ANSI/AAMI ES1-1993 standard is selected.

To measure the leakage current through each applied part or lead and combination of lead connections (all other or between two), push the **Lead to Lead** softkey from the Leakage Test main menu shown in Figure 20. Figure 25 shows the electrical connections between the Product and the DUT when it does a Lead-to-Lead (Patient Auxiliary) Leakage Current Test.

The Lead-to-Lead (Patient Auxiliary) Leakage test adds a diagram of the applied parts connection posts to the display, as shown in Figure 24. In the figure, the applied parts post RA/R is shown above the other posts. This shows that the leakage measurement is from RA/R to all others. To move to the subsequent applied part post, push **⏩**. The first post will show inline with the other posts while the LL/F post shows above all others. This shows the second leakage measurement is from LL/F to all others. Continue to push **⏩** or **⏪** to move from one connection post to another.

After each post is isolated individually, the Lead-to-Lead (Patient Auxiliary) Leakage test measures current of three different combinations of posts tied together: RA/R and LL/F, RA/R and LA/L, or LL/F and LA/L.

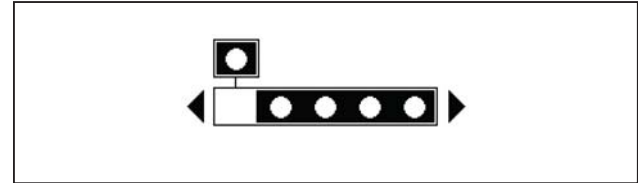

fis107.eps

Figure 24. Applied Parts Connection Posts Display

The Lead-to-Lead (Patient Auxiliary) Leakage test can make different fault measurements. Push **POLARITY** to switch the polarity of the mains voltage applied to the test receptacle between Normal, Off, Reverse, and Off. Push **NEUTRAL** to open and close the neutral connection to the test receptacle. Push **EARTH** to open and close the earth or ground connection to the test receptacle.

Note

If there are more than five applied parts to connect to the Product, see the How to Use the 1-to-10 Adapter section in this manual.

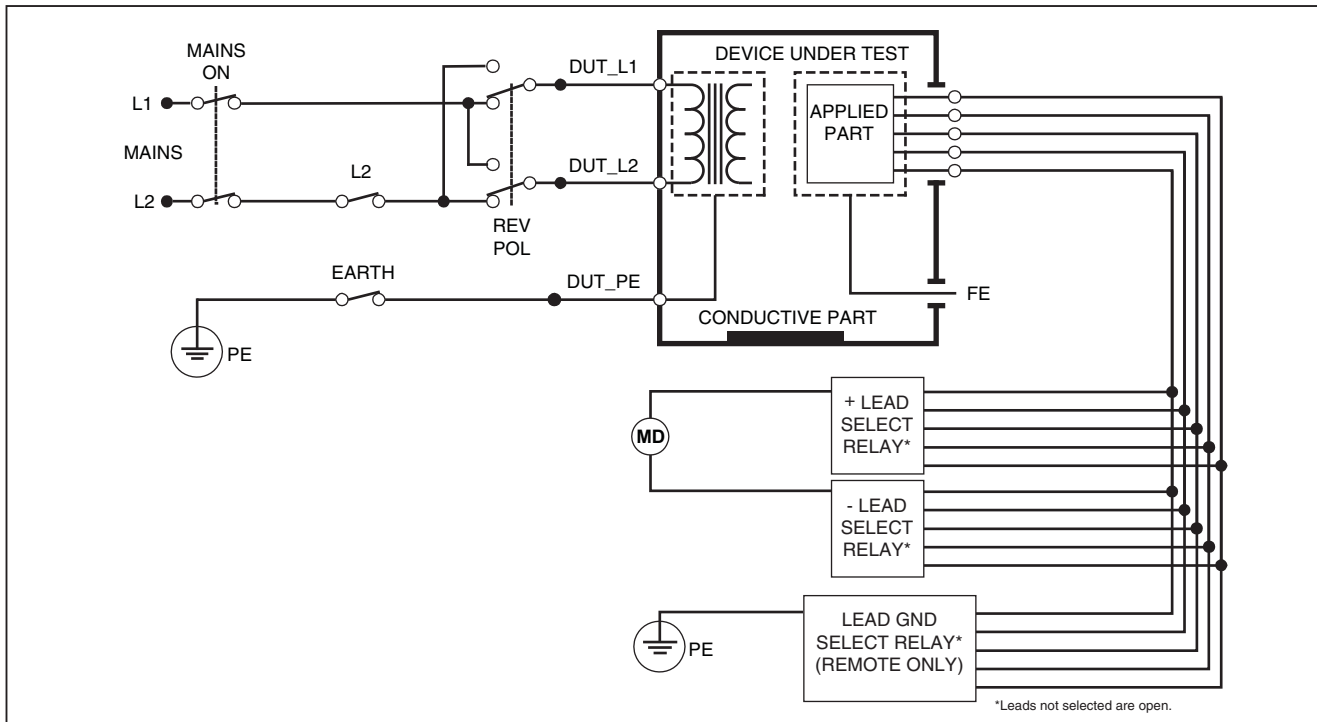

gtv30.eps

Figure 25. Lead-to-Lead (Patient Auxiliary) Leakage Current Test Schematic

The outlet conditions below apply when you do this test:

- Normal Polarity
- Normal Polarity, Open Neutral
- Normal Polarity, Open Earth
- Reversed Polarity, Open Neutral
- Reversed Polarity, Open Earth

Lead Isolation (Mains on Applied Part) MAP Leakage Test

Note

The Lead Isolation (Mains on Applied Part) leakage test is available when the IEC60601 & ANSI/AAMI standard is selected.

The Lead Isolation (Mains On Applied Parts) Leakage Current test measures the current that flows in response to an isolated AC voltage applied between a selected applied part, group of applied parts, or all applied parts, and Earth (and any conductive part connected to the RED terminal). Figure 26 shows the electrical connections between the Product and the DUT when it does a Mains on Applied Part Leakage Current Test.

Note

With 60601 standard selected, the MAP test voltage is available in Normal and Reverse (180 degrees out of phase with mains).

To do a Lead Isolation (Mains on Applied Part) test:

1. Push **μA**.
2. Push the **More** softkey.
3. Set the applied part groupings with **▲** and **▼**.

Note

Refer to the test standard when you decide the type of the applied parts and how they must be grouped for the test.

4. Push the **Select** softkey.
5. Push the **Lead Isolation** softkey.
6. Push **◀** or **▶** to set the desired applied part connection.
7. Push **TEST** to apply the voltage and read the leakage current in the display.

Push **⏪** and **⏩** to scroll through the applied part connections or groupings. Push **TEST** for each connection configuration to thoroughly test the DUT.

The outlet conditions below apply when you do this test:

- Normal Polarity
- Reverse Polarity

Note

If there are more than five applied parts to connect to the Product, see the How to Use the 1-to-10 Adapter section in this manual.

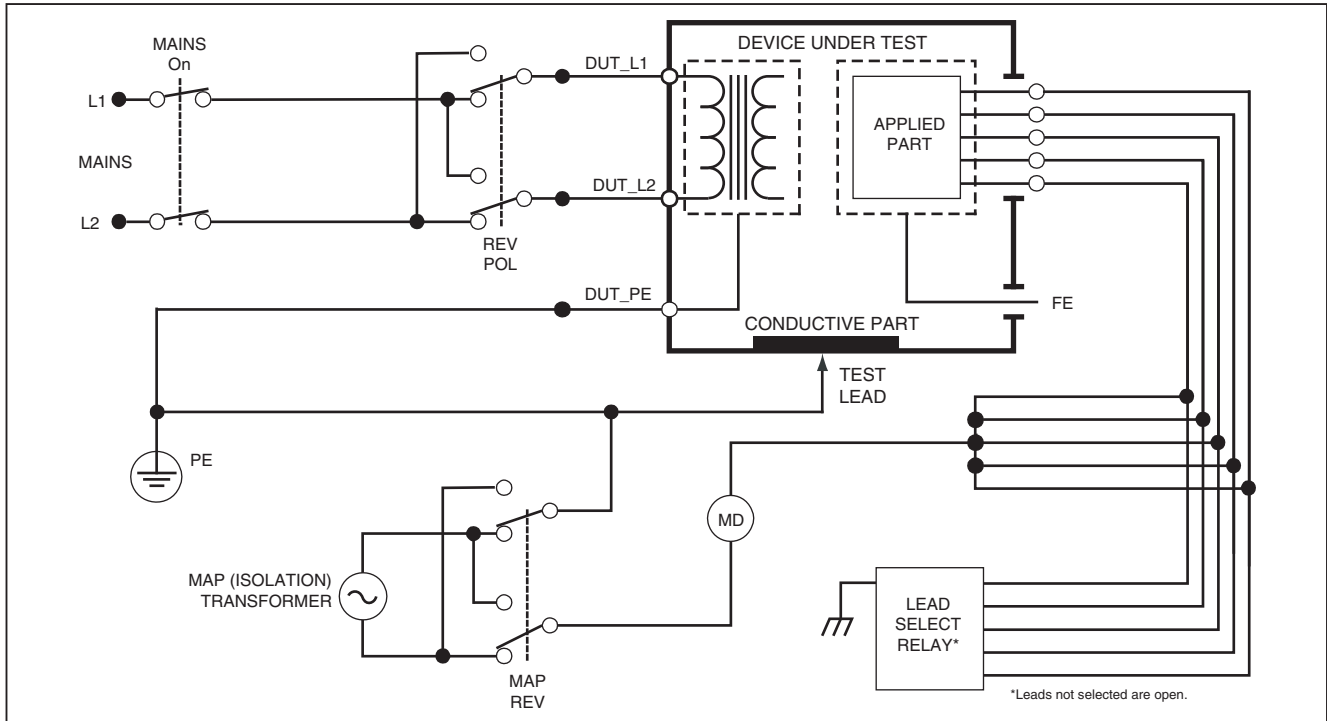

Figure 26. Lead Isolation (Mains On Applied Parts) Leakage Test Schematic

gtv31.eps

Alternative Equipment Leakage Test

Note

The alternative equipment leakage test is available when the EN62353 standard is selected.

The Alternative Equipment Leakage test, applies the voltage source between short-circuited equipment outlet mains live, neutral, and equipment outlet earth, the exposed conductive surface on the housing, and all applied parts short-circuited together. The test disconnects equipment from mains. The current which flows over the insulation of the DUT is measured.

This test is not applicable for equipment with internal electrical power source. The switches in mains part must be closed for this measurement.

To do an alternative equipment leakage test:

1. Push **μA**.
2. Push the **Alternative Equipment** softkey.
3. Push **TEST** to apply the voltage and read the current in the display.

Figure 27 shows the electrical connections between the Product and the DUT for the Alternative Equipment Leakage Test.

The outlet conditions below apply when you do this test:

- Closed Earth
- Open Earth

Note

If there are more than five applied parts to connect to the Product, see the How to Use the 1-to-10 Adapter section in this manual.

Alternative Applied Part Leakage Test

Note

The Alternative applied part leakage test is available when the EN62353 standard is selected.

The Alternative Applied Part Leakage test applies the test voltage between short-circuited applied parts of a single function and the short-circuited equipment outlet mains live, neutral, earth, and exposed conductive surface on the housing. This test should only be done for equipment with F-Type applied parts. For equipment with multiple applied parts, test each group of applied parts of a single function in turn with all others float during the test. All applied parts can be connected to the applied parts jacks and the lead selection will float those not selected.

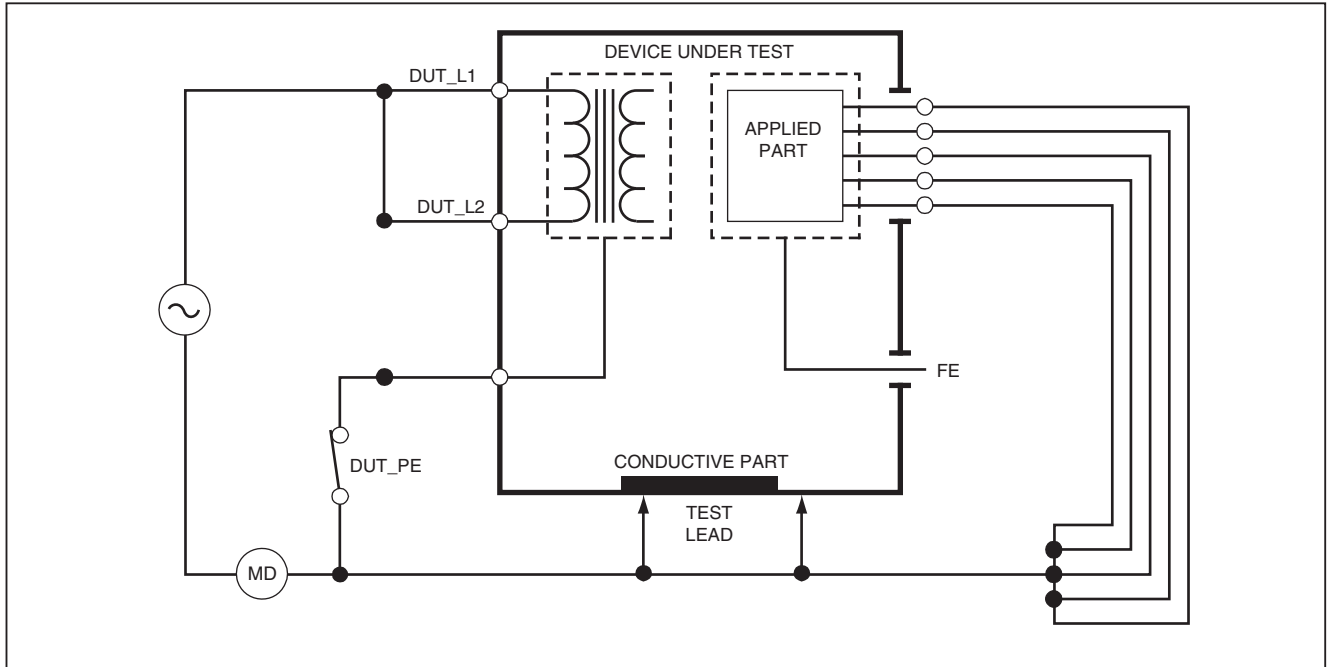

faw22.eps

Figure 27. Alternative Equipment Leakage Current Test Schematic

To do an alternative applied part leakage test:

1. Push **μA**.
2. Push the **More** softkey.
3. Set the applied part groupings with **▲** and **▼**.
4. Push the **Select** softkey.
5. Push the **Alternative A.P.** softkey.
6. Push **TEST** to apply the test voltage and read the current in the display.
7. Push **⏪** or **⏩** to advance to the next applied part group(s) of a single function if applicable. Push **TEST** to read leakage current for each group.

Figure 28 shows the electrical connections between the Product and the DUT for an Alternative Applied Part Leakage current test.

Note

If there are more than five applied parts to connect to the Product, see the How to Use the 1-to-10 Adapter section in this manual.

Direct Equipment Leakage Test

Note

The Direct Equipment Leakage test is available when the EN62353 standard is selected.

The Direct Equipment Leakage Current test measures the leakage current between all applied parts and the exposed conductive surface on the housing to mains earth.

To do a direct equipment test:

1. Push **μA**.
The direct equipment test is the default test and must already be selected.
2. Push **TEST** to apply the voltage and read the leakage current in the display.

Figure 29 shows the electrical connections between the Product and the DUT for a Direct Equipment Leakage Current Test.

The outlet conditions below apply when you do this test:

- Normal Polarity, Closed Earth
- Normal Polarity, Open Earth
- Reversed Polarity, Closed Earth
- Reversed Polarity, Open Earth

Note

If there are more than five applied parts to connect to the Product, see the How to Use the 1-to-10 Adapter section in this manual.

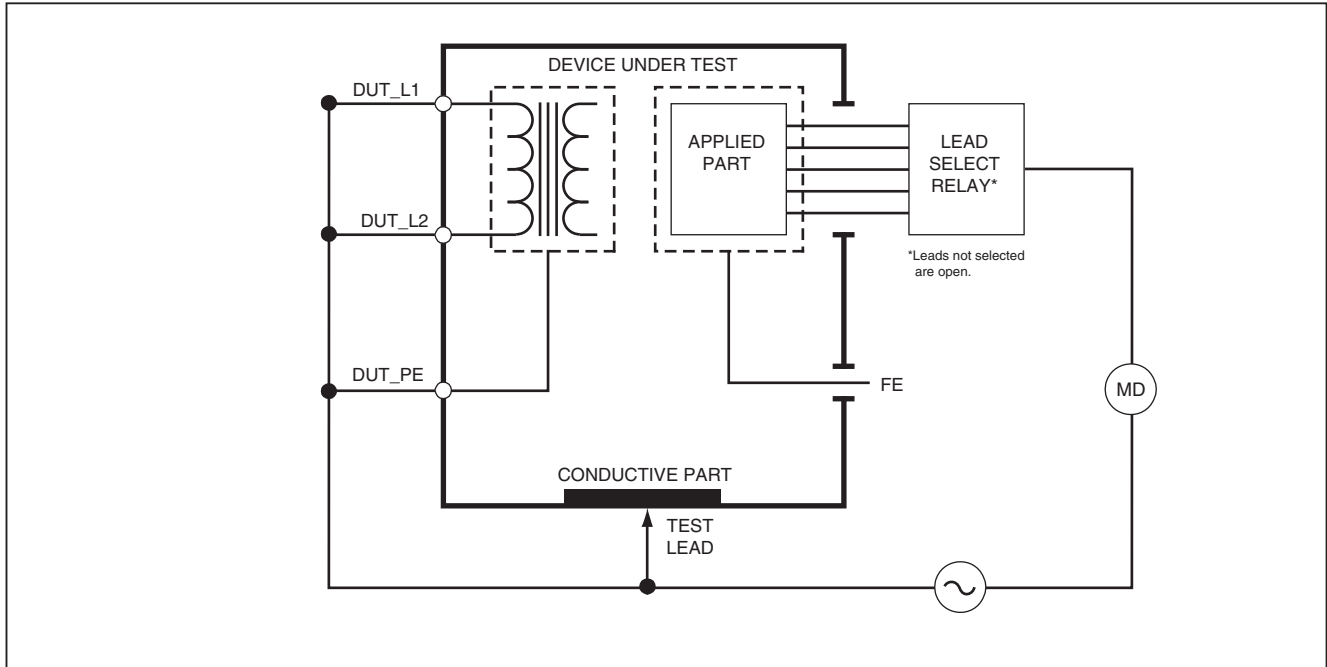

gtv23.eps

Figure 28. Alternative Applied Part Leakage Test Schematic

Direct Applied Part Leakage Test

Note

The Direct Applied Part Leakage test is available when the EN62353 standard is selected.

The Direct Applied Part Leakage Current test measures the leakage current between all applied parts of one function and the exposed conductive surface on the housing, to mains earth. For equipment with multiple applied parts, you must do the test on each group of one function each in turn while all others float. This test must only be done for equipment with F-Type applied parts.

For Type B applied part, see direct equipment leakage schematic in Figure 29.

To do a direct applied part leakage test:

1. Push **[μ A]**.
2. Push the **More** softkey.
3. Set the desired applied part groupings with **[\leftarrow]** and **[\rightarrow]**.
4. Push the **Select** softkey. The Direct A.P. test must already be set.
5. Push **[\leftarrow]** or **[\rightarrow]** to set the applied part test configuration.

6. Push **TEST** to apply the test voltage and read the current in the display.
7. Push **[\leftarrow]** or **[\rightarrow]** to advance to the next group of applied parts, if applicable.

Figure 30 shows the electrical connections between the Product and the DUT for a Direct Applied Part Leakage Current Test.

The outlet conditions below apply when you do this test:

- Normal Polarity
- Reversed Polarity

Note

If there are more than five applied parts to connect to the Product, see the How to Use the 1-to-10 Adapter section in this manual.

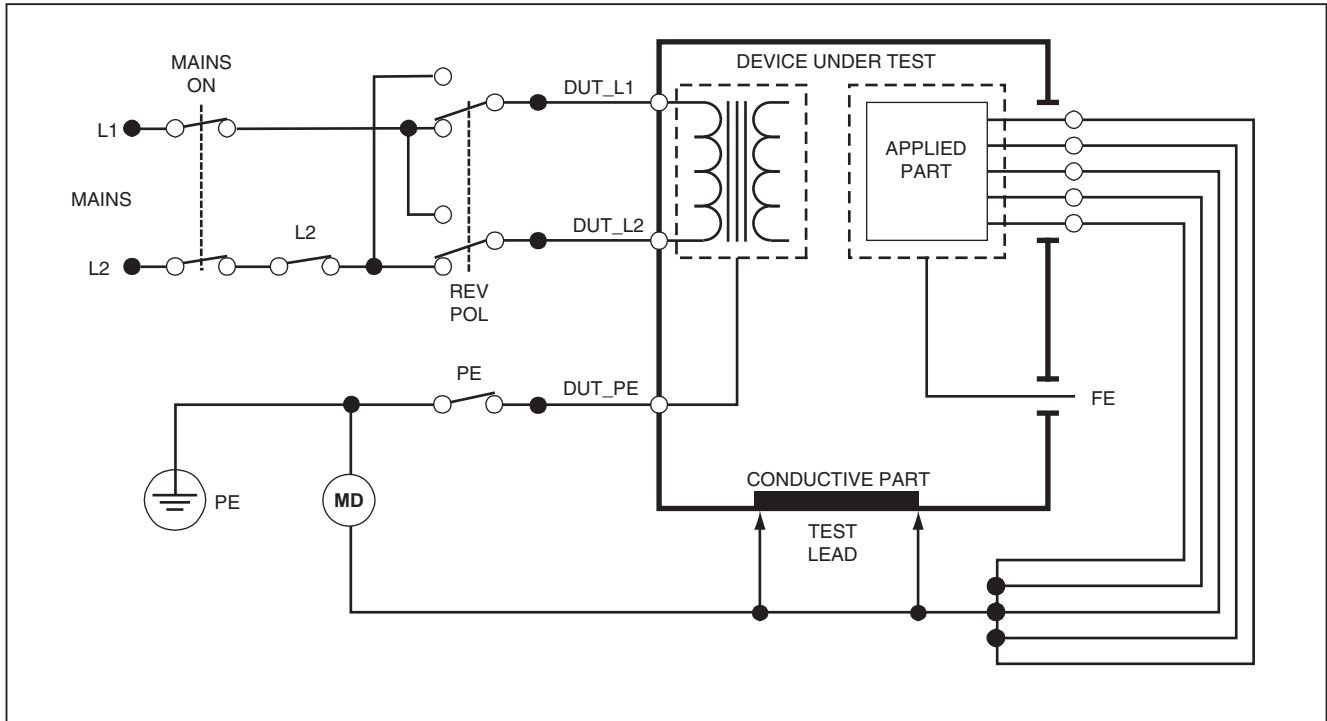

faw24.eps

Figure 29. Direct Equipment Leakage Test Schematic

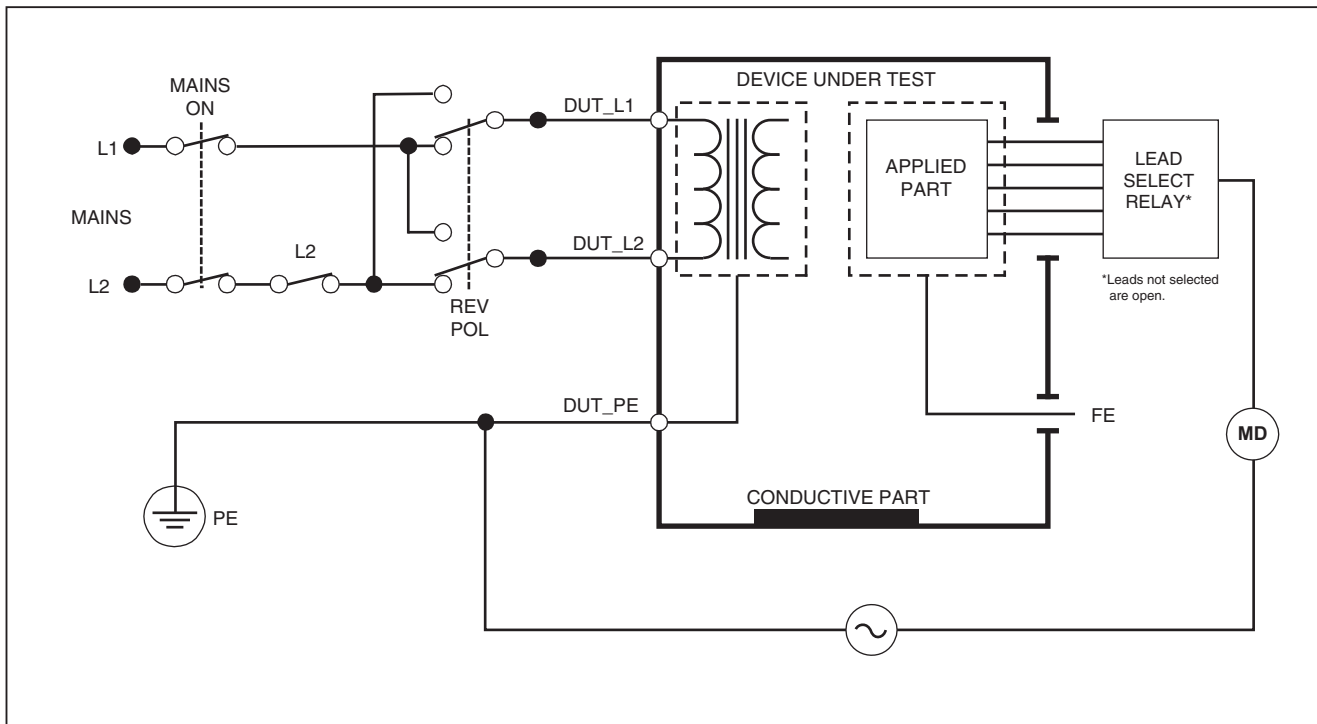

gtv25.eps

Figure 30. Direct Applied Parts Leakage Current Test Schematic

Differential Leakage Current Test

Note

The Differential Leakage Current test is available when the EN62353 standard is selected.

The differential leakage current test measures the magnitudes of the differential current that flows in the Equipment Outlet live and neutral, with power applied to the equipment outlet. All applied parts must be connected for this test, if equipment has applicable applied parts.

To do a differential leakage current test:

1. Push μA .
2. Push the **Differential** softkey.

Figure 31 shows the electrical connections between the Product and the DUT for a Differential Leakage Current test.

The outlet conditions below apply when you do this test:

- Normal Polarity, Closed Earth
- Normal Polarity, Open Earth
- Reversed Polarity, Closed Earth
- Reversed Polarity, Open Earth

Note

If there are more than five applied parts to connect to the Product, see How to Use the 1-to-10 Adapter later in this manual.

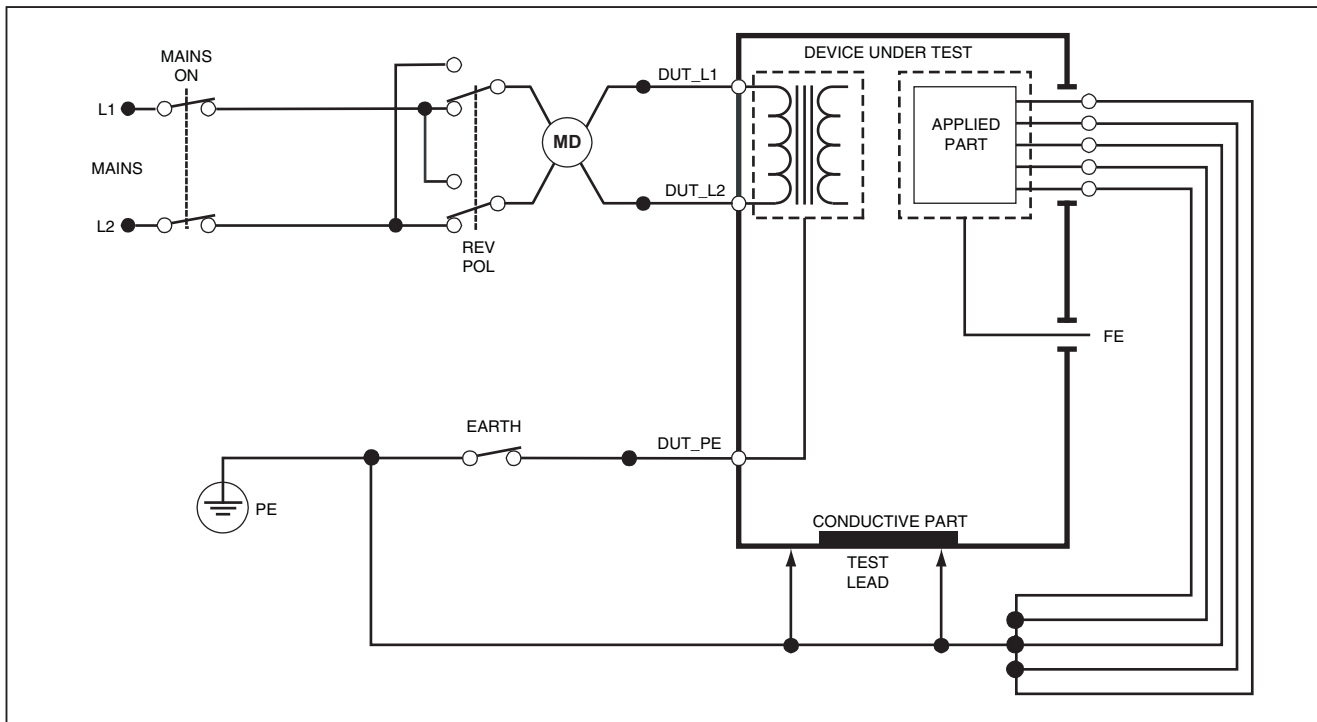

gtv32.eps

Figure 31. Differential Leakage Current Test Schematic

How to Use the 1-to-10 Adapter

The 1-to-10 Adapter, an optional accessory, increases the number of lead or applied parts connections to the Product from 5 to 14. The adapter connects a maximum of 10 leads together into a one lead that is connected to one of the input jacks of the Product. The other four Product input jacks can also be used in conjunction with the Adapter. More leads can be added with multiple 1-to-10 Adapters.

The example in Figure 32 shows one application of the Adapter. The Defibrillator/Monitor in the example has 10 ECG leads, two pacer leads, and two defibrillator paddles which must be connected together, and in groups if single function, for current leakage per IEC62353. The example shows the ECG leads to be snap type connectors and two BJ2ECG adapters are shown connected to the Adapter. If the ECG leads do not have snap connectors, then the Universal Snap to Banana Adapter can be used to make the connections to the Adapter.

The common lead from the Adapter is plugged into the RA jack (1st jack) of the Product. Using four sheathed test leads with alligator clips, connect the two defibrillator paddles into the LL and LA Product jacks and the two pacer leads into the RL and V1 jacks. Set the connection that ties all five Product jacks together. This will measure leakage current in all fourteen leads. The applied part group of 1, 2, and 2 lets you test groups of applied parts of one function.

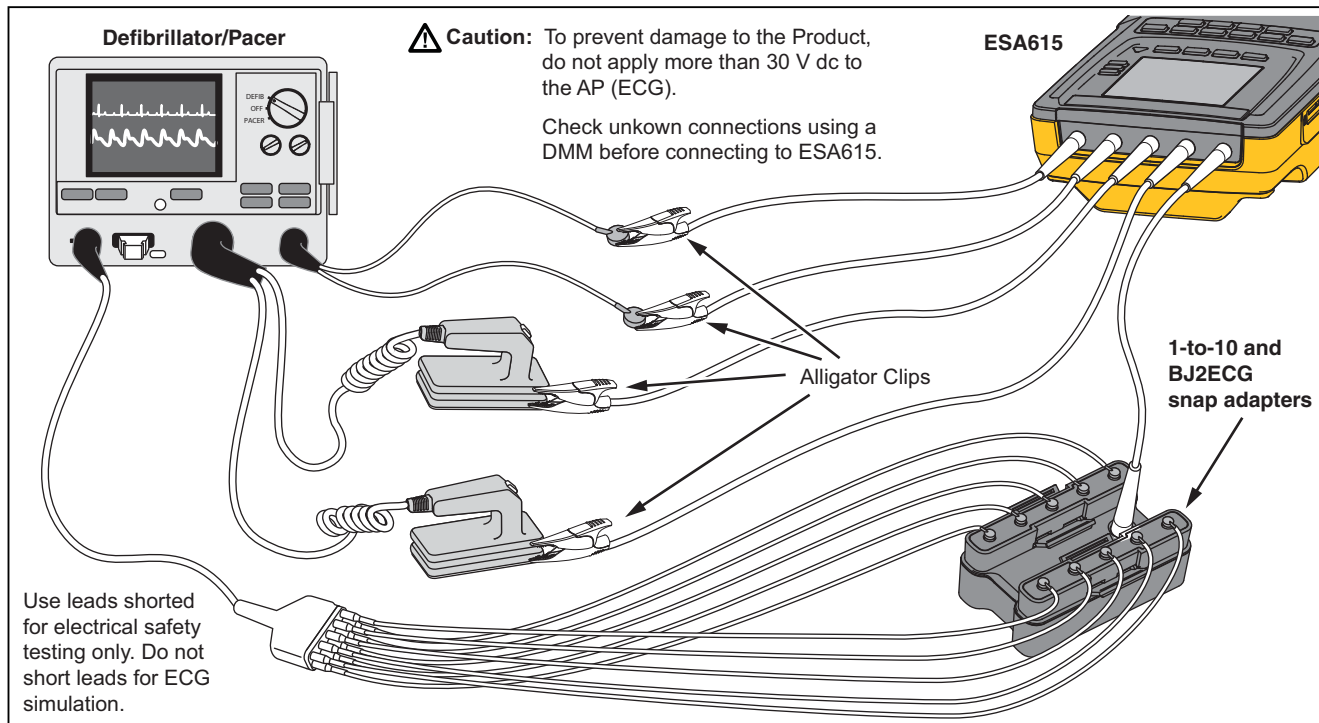
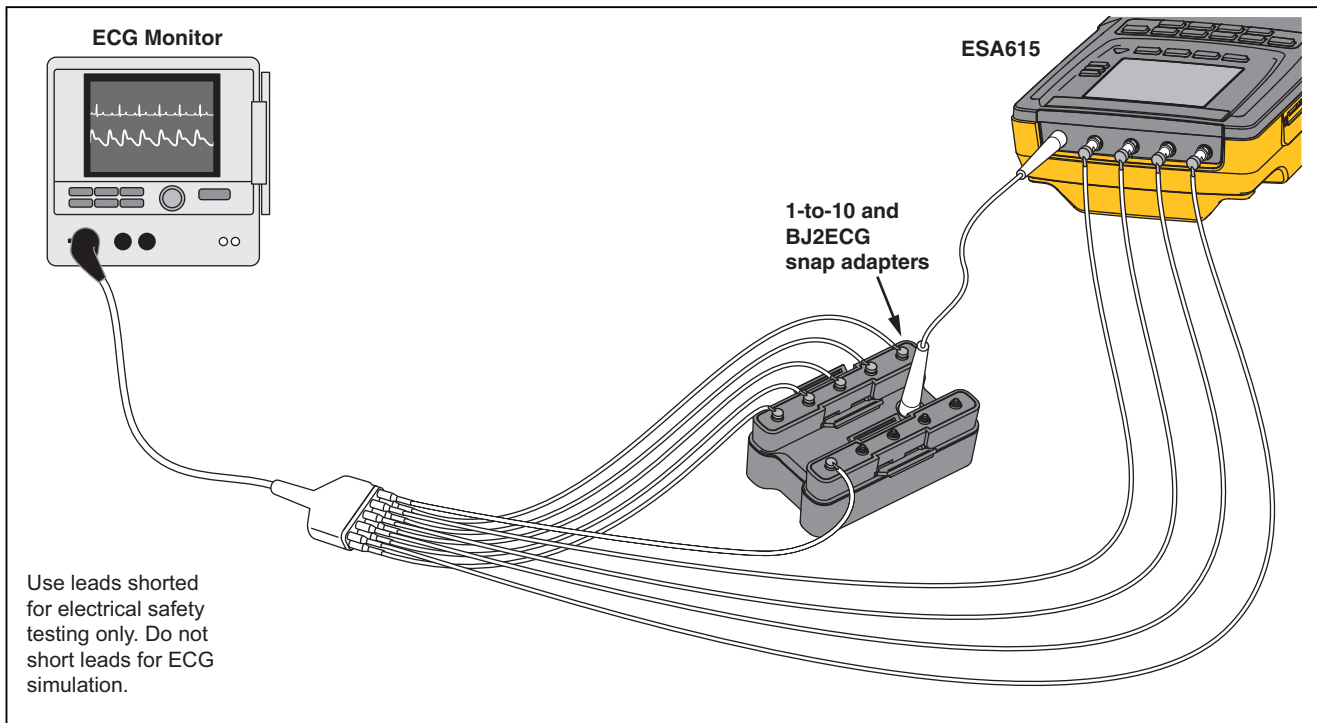

Figure 32. 1-to-10 Adapter Connections

gtv120.eps

When you do an applied parts test with the AAMI/NFPA-99 standard, the normal connections of RA, LL, LA, and RL are made to their related input jacks. Four adapters from the Universal Snap to Banana Adapter set will be necessary for the first four connections. The other chest leads are connected to the Adapter and the common lead from the Adapter is connected to the V1 jack (5th jack) of the Product. See Figure 33. This configuration lets you isolate the RA, LL, LA, and RL leads from each other and the other chest leads, which are shorted together, while the Product does the leakage tests.



gtv121.eps

Figure 33. ECG Lead Connection with 1-to-10 Adapter

How to Do Point-To-Point Measurements

The Product can make voltage, resistance, and low current measurements through its Point-to-Point function. To access the Point-to-Point function menu shown in Figure 34, push . Softkeys **F1** through **F3** are used to set the measurement function.

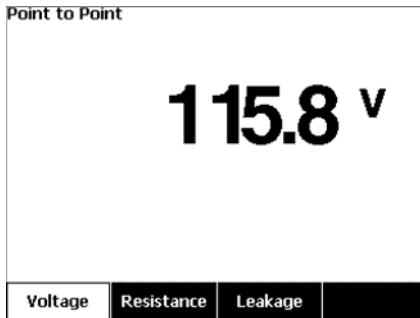

glv128.jpg

Figure 34. Point-To-Point Function Menu

Measure Voltage

To make a voltage measurement:

1. Push the **Voltage** softkey from the Point-To-Point menu.
2. Put test leads in the RED (V/Ω/A) and BLACK jacks.
3. Put the probe tips across the unknown voltage and read the measurement in the display.

The Product measures a maximum of 300 volts ac.

Measure Resistance

To make a resistance measurement:

1. Push the **Resistance** softkey from the Point-To-Point menu.
2. Put test leads in the RED (V/Ω/A) and BLACK jacks.
3. Null lead resistance by shorting the leads together and Push the **Zero Leads** softkey.
4. Put the probes across the unknown resistance and read the measurement in the display.

The Product measures resistances to a maximum of 2.0 Ω.

Measure Current

The Product can make dc only, ac only, and ac+dc current measurements to a maximum of 10 mA. To do a current measurement:

1. Push the **Leakage** softkey from the Point-To-Point menu.
2. Push \odot or \ominus set the ac only, dc only, or ac+dc measurement mode.
3. Put test leads in the RED (V/ Ω /A) and BLACK jacks.
4. Put the probe tips on the two points the unknown current may flow and read the measurement in the display.

How to Simulate ECG Waveforms

The Product can put different waveforms on the applied parts connection posts. These signals are used to measure the performance parameters of ECG monitors and ECG strip printers. See Figure 36 for the connections between the Product and an ECG monitor. For monitors that use the snap style connectors, put the BJ2ECG adapter into the connectors at the top of the Product and connect the monitor leads to the snap connectors on the adapter.

Note



If the ECG monitor/interpreter has banana posts, use the optional universal snap to banana adapter to connect to the Product.

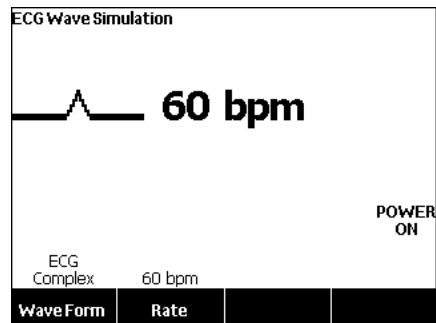

To access the ECG Simulation Waveform menu shown in Figure 35, push . From this menu, a number of waveforms are set through **F1**, and the rate or frequency of the waveform is set through **F2**.



gtv109.bmp

Figure 35. ECG Waveform Simulation Menu

To output one of the predefined waveforms, push the **Wave Form** softkey. A scroll box with  next to it appears above the softkey label. Use  or  to scroll through the different waveforms.

For all waveforms but VFIB and Triangle, the rate or frequency of the waveform is adjusted through the **Frequency** or **Rate** softkey. For some waveforms, there are more than two frequency or rate selections. For those waveforms, push the **Frequency** or **Rate** softkey to open a scroll box above the softkey label with  next to it. Use  or  to select the frequency or rate. For those waveforms that have only two frequencies or rates, the **Frequency** or **Rate** softkey is a toggle, where each push of the softkey switches to the other value.

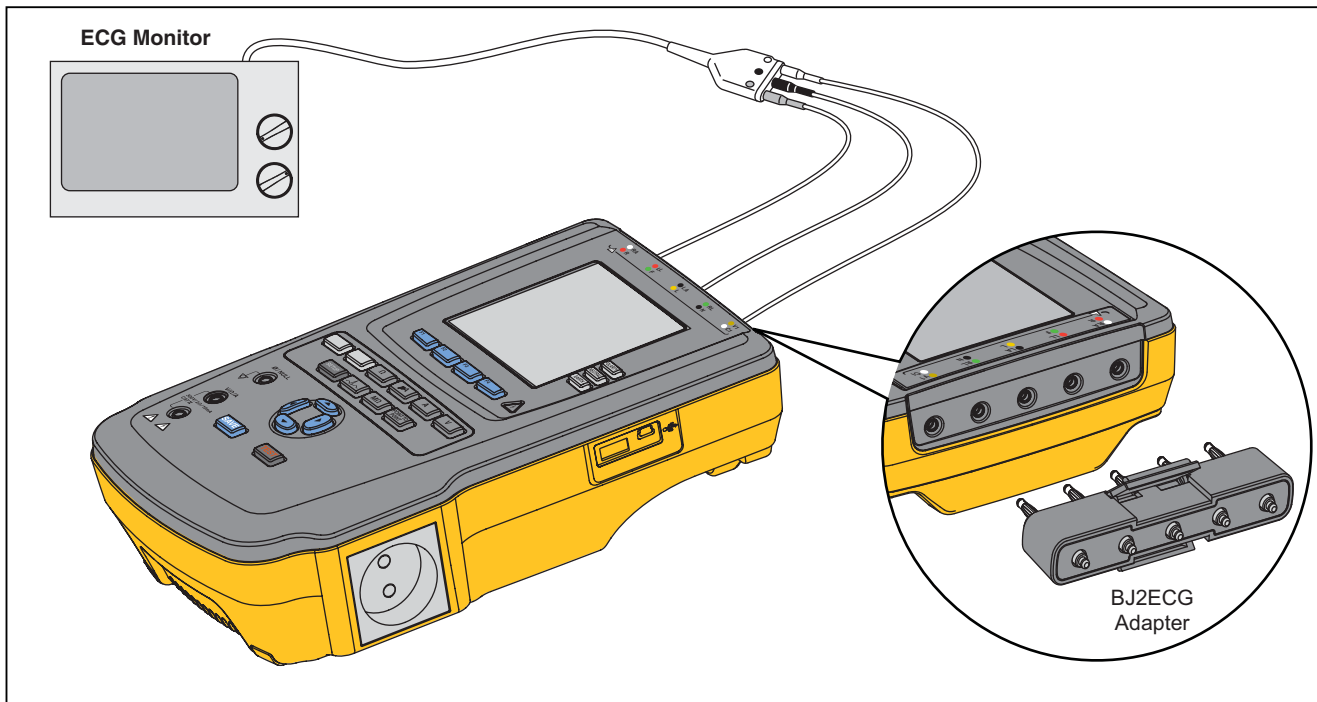

gtv115.eps

Figure 36. ECG Monitor Connections

Memory

The Product keeps test results data and test sequences on an SD memory card. The memory card holds a minimum of 100 test sequences and 1000 test results. Each test result can be recalled to the display of the Product or exported to a PC.

Note

The Product can show the last 200 test results. All results in the Product can be exported to a PC.

To remove the memory card:

1. Push in on the memory card and release it.
2. The memory card will eject out of the slot.
3. Hold the memory card with your fingers and remove it from the product.

Note

With the memory card removed, no test sequences will show in the test library list. You cannot make new test sequence without the card installed in the Product.

To install the memory card:

1. Insert the card with the contacts toward the back.
2. Push the card all the way in until you hear it click.
3. Release the card.

Test Sequences

The test sequence feature automates the tests you do on a DUT. You make test sequences with the built-in test sequence wizard. A different procedure is to start with a test sequence that is already in the test library and change it to make a new test sequence. The test sequences and test results are kept on the memory card.

Factory Supplied Test Sequences

Table 6 is a list of factory supplied test sequences that are on the memory card that ships with the Product. Each factory supplied test sequence is prefixed with the test standard number. For example, the 60601-1 Monitor test sequence is based on the 60601-1 test standard.

Table 6. Factory Supplied Test Sequences

Test Sequence	Description ^[1]
60601 3rd Patient Monitor	3rd Ed., Class I, 5 ECG
60601 3rd Defibrillator	3rd Ed., Class I, 2 Paddles and 3 ECG
60601 3rd Infusion Device	3rd Ed., Class II, 1 No AP
60601 3rd Ultrasound Device	3rd Ed., Class I, 1 Probe
60601 3rd Generic Device	3rd Ed., Class I, No AP
60601 3rd System	3rd Ed., Class I, No AP
62353-Alt. Patient Monitor	Class I, 5 ECG
62353-Alt. Defibrillator	Class I, 2 Paddles and 3 ECG
62353-Alt. Infusion Device	Class II, 1 No-AP
62353-Alt. Ultrasound Device	Class I, 1 Probe
62353-Alt. Generic Device	Class I, No AP
NFPA99 Patient Monitor	Class I, 5 ECG
NFPA99 Defibrillator	Class I, 2 Paddles and 3 ECG
NFPA99 Infusion Device	Class II, 1 No AP

Table 6. Factory Supplied Test Sequences (cont.)

Test Sequence	Description ^[1]
NFPA99 Ultrasound Device	Class I, 1 Probe
NFPA99 Generic Device	Class I, No AP
ANSI/AAMI ES-1 Patient Monitor	Class I, 5 ECG
ANSI/AAMI ES-1 Defibrillator	Class I, 2 Paddles and 3 ECG
ANSI/AAMI ES-1 Infusion Device	Class II, 1 No AP
ANSI/AAMI ES-1 Ultrasound Device	Class I, 1 Probe
ANSI/AAMI ES-1 Generic Device	Class I, No AP
[1] Class designations refer to applicable electrical safety standard definitions for devices, not FDA medical device definitions.	

How to Make a Test Sequence







You can make a new test sequence from a different test sequence or make a new one.

Make a New Test Sequence

To make a new test:

1. Push .
2. Push the **Test Library** softkey.
3. Push the **New** softkey.

A test sequence wizard steps you through the configuration of the test sequence. There are five setup steps.

1. Push  or  to highlight a test standard and push .
2. Push  or  to highlight a device class and push .
3. Configure the Applied Parts (A.P.).

Note

A USB keyboard or barcode reader can be used to type in the A.P. name.

If the DUT does not have applied parts, push the **Next Step** softkey to skip the applied parts configuration.

If the DUT has applied parts, push **New A.P.**. You must name the applied part and show how many DUT applied parts are in the configuration.

The Product has five applied parts inputs. If you set more than five applied parts, an error message shows in the display. If the DUT has more than five applied parts, you can use the 1-to-10 adapter. See the How to Use the 1-to-10 Adapter section to learn more.

If you attach multiple applied parts to one input, then you must set the **Tied Setting to Tied**. The Product sets the subsequent available input for the applied parts that are tied together. The position icon in the display shows inputs that are configured as dots and inputs not configured as circles. Figure 37 shows the position icon for one input configured and four inputs not configured.



gtv127.bmp

Figure 37. Input Position ICON

To put a DUT applied part on each of the Product inputs, set **Tied Settings to Not Tied**. The Product will show the subsequent available inputs as configured for this configuration.

The last applied parts variable is the **Type**. Highlight the Type variable and push **ENTER**. Highlight a type from the type list and push **ENTER**.

Push the **Done** softkey to complete the applied part configuration.

To edit an applied part configuration, use **▲** or **▼** to highlight the A.P. configuration and push **ENTER**.

4. Edit test settings.

Table 7 is a list of test settings with their descriptions and default values.

To set one of the test setting, push **▲** or **▼** to highlight a test setting and push **ENTER**. After you change the setting, push the **Done** softkey.

5. Name the test sequence. When you push the **Next Step** softkey in the edit test settings step, the Product automatically names the sequence Test Sequence followed by the date and time. To accept the default name, push the **Next Step** softkey. To change the name, push the **Edit** softkey.

Note

A USB keyboard or barcode reader can be used to edit the test sequence name.

The test sequence is complete. To put the test sequence on the memory card, push the **Save** softkey. To see the test sequence parameters before you save it, push the **Edit** softkey.

Table 7. Test Settings for Test Sequences



Test Setting	Description	Default Value
Pause after power on	If set to Yes, delays the start of the test by the time set in the Power on delay parameter when power is applied to the DUT.	No
Pause before power off	If set to Yes, delays the start of the test by the time set in the Power off delay parameter when power is removed from the DUT.	No
Power on delay	The time the Product will wait before it does the subsequent step after power is applied to the DUT. The range is 0 to 9999 seconds.	2 sec
Power off delay	The time the Product will wait before it does the subsequent step after power is removed from the DUT. The range is 0 to 9999 seconds.	0 sec
Test Speed ^[1]	When set to Normal, the Product does a leakage current measurement in 5 seconds and an insulation resistance test in 1 minute. When set to Rapid, the Product measures leakage current as fast as possible and an insulation resistance test in 3 seconds.	Normal
Test Mode	When set to Automatic, the Product does each test sequence step automatically. When set to Step-by-Step, you must push the Next Step softkey to move to the subsequent step in the sequence.	Automatic
Halt on Test Failure	When set to Yes, the Product stops the test sequence when a fault is sensed.	Yes

Table 7. Test Settings for Test Sequences (cont.)

Test Setting	Description	Default Value
Multiple PE Tests	If set to Yes, the Product prompts you to repeat PE tests or continue.	No
Multiple Non-Earth Leakage	If set to Yes, the Product prompts you to repeat non-earth leakage tests or continue.	No
Patient Lead Records storage ^[2]	When set to Store all, all results are put into the test results. If set to Store worst/last, only the worst measured value is put into the test results. If set to store worst/last and all measured values are the same, then the last value is put into the test results.	Store worst/last
Insulation Test Voltage	Sets the insulation test voltage to 250 V dc or 500 V dc.	500 V dc
Reverse Polarity	If set to No, reverse polarity tests will be skipped.	Yes
<p>[1] You can change the test speed parameter on a test sequence to decrease the time necessary to do a test sequence.</p> <p>[2] Applies to leakage current and multiple PE tests only.</p>		

Make a Test Sequence from a Test Sequence in the Test Library

To make a test sequence from a test sequence already in the test library:

1. Push .
2. Push the **Test Library** softkey.
3. Push  or  to highlight a test sequence name.

Note

*Push softkey **F1** to toggle between an A to Z or Z to A sort of the test sequences.*

4. Push the **View/Edit** softkey.
5. Push the **Save as New** softkey.
6. Type in a new name with the screen keyboard.

Note



A USB keyboard or barcode reader can be used to edit the test sequence name.

7. Push the **Done** softkey.
The new test sequence steps are filled in with the steps from the initial test sequence.

8. Push the **Edit** softkey.
Go through each setup step of the test sequence and accept the parameters or change them for the new test sequence.
9. Push the **Save** softkey to save the test sequence and exit the wizard.

Edit a Test Sequence

To change one or more steps of a test sequence:

1. Push .
2. Push the **Test Library** softkey.
3. Push  or  to highlight a test sequence name.

Note

*Push softkey **F1** to toggle between an A to Z or Z to A sort of the test sequences.*

4. Push the **View/Edit** softkey.
5. Push the **Edit** softkey.

You go through each step of the test sequence and accept the step parameters or change them.

Do a Test Sequence

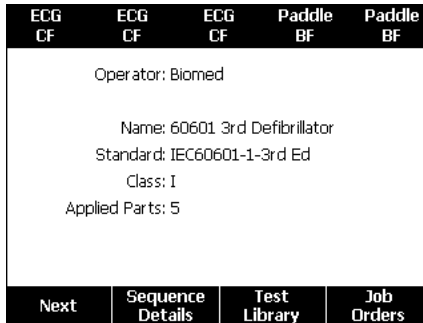

To do a test sequence:

1. Push  to show the test sequence screen in Figure 38.



gtv125.bmp

Figure 38. Test Sequence Screen

2. Push the **Test Library** softkey.
3. Push  or  to highlight a test sequence name.

Note

*Push softkey **F1** to toggle between an A to Z, Z to A, by date sort of the test sequences.*

4. Push .

Note

*To see the details of the test sequence you are about to start, push the **Sequence Details** softkey.*

5. Push the **Next** softkey.

The equipment information screen in Figure 39 shows in the display.

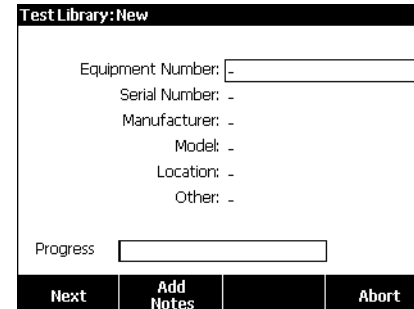

gtv126.bmp

Figure 39. Equipment Information Screen

The number, serial number, manufacturer, model, and location of the Device Under Test can be typed in to help identify the DUT on the test results.

Note

A USB keyboard or barcode reader can be used to type in the DUT information. You can use a barcode reader to automatically move through each field if it automatically sends a carriage return.

When the test sequence step is a visual inspection, you must push the **Pass**, **Fail**, or **N/A** softkey to move on to the subsequent test step.

When the Product measures a value(s) for a test, Testing shows in the display. When the test step is done, the results are shown with PASS or FAIL in the display.

To add comments when a test step ends, push the **Add Comments** softkey. When you see individual results of a Test Summary, you can push the **Add Comments** softkey to type in more information about the test step.

When the test sequence is done, a name is made from the equipment number, the date, and the time. To change the name, push **ENTER** or the **Edit** softkey. To put the test sequence on the memory card, push the **Save** softkey.

Show Test Results

To show test results in the display:

1. Push **Test Results**.
2. Push **▼** or **▲** to highlight a test results name.

Note

*Push softkey **F1** to toggle between sort results by date or sort A-Z.*

3. Push **ENTER** to show the test and its results in the display.
4. Push **▲** or **▼** to highlight a test result.
5. Push **ENTER** to show the test results in the display.
6. Push the **Back** softkey to go back to the test results list.

Note

A USB keyboard or barcode reader can be used to edit the test results name.

When you push the **Start Test Sequence** softkey, the complete test sequence starts.

Delete a Set of Test Results

To delete a test result:

1. Push .
2. Push  or  to highlight a test result name.

Note

*Push softkey **F1** to toggle between sort results by date or sort A-Z.*

3. Push the **Delete** softkey.
A delete confirmation screen will show in the display.
4. Push the **Delete** softkey.

Maintenance

Warning

To prevent possible electrical shock, fire, or personal injury:

- **Turn off the Product and remove the mains power cord. Stop for 2 minutes to let the internal circuits discharge before you open the fuse door or remove Product covers.**
- **Do not operate the Product with covers removed or the case open. Hazardous voltage exposure is possible.**
- **Disconnect the mains power cord before you remove the Product covers.**

- **Remove the input signals before you clean the Product.**
- **Use only specified replacement parts.**
- **Use only specified replacement fuses.**
- **Have an approved technician repair the Product.**

The Product is a calibrated measurement instrument. Use the necessary precautions to prevent mechanical abuse that could change the calibrated adjustments.

Fuse Test and Fuse Replacement

Warning

To prevent electric shock, remove all power cords and test leads from the Product before you open the fuse door.

For electrical protection of the equipment outlet, the Product uses two fuses, one in the live (L1) line and one in the neutral (L2) line. To do a fuse test:

1. Turn the Product so the case bottom is up. See Figure 40.
2. Flip up the tilt stand.
3. Remove the screw in the fuse door with a #2 Phillips head screwdriver and lift the fuse door from the Product.
4. Remove the two fuses from the Product.

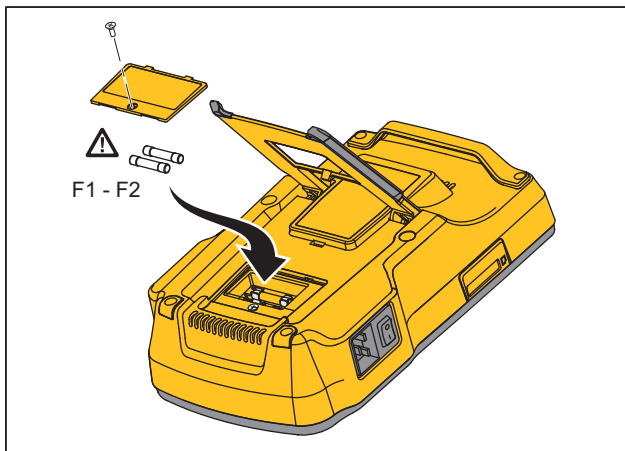

gtv111.eps

Figure 40. Fuse Access

5. Use a multimeter to measure the continuity of each fuse.

If a fuse does not show continuity, replace the fuse(s) with a fuse of the same current and voltage rating. Applicable fuse ratings are posted on the case bottom label of the Product. Table 8 is a list of available fuses with Fluke Biomedical part numbers.

6. Reinstall the fuse door and secure it with the screw.

How to Clean the Product

⚠⚠ Warning

To prevent electric shock, do not clean the Product plugged into mains or attached to a DUT.

⚠ Caution

Do not pour fluid onto the Product surface. Fluid in the electrical circuitry can cause the Product to fail.

⚠ Caution

Do not use spray cleaners on the Product. This can cause fluid to leak into the Product and damage electronic components.

Clean the Product occasionally with a damp cloth and weak detergent. Try to prevent the entrance of liquids.

Clean the adapter cables with the same precautions. Examine them for damage and deterioration of the insulation. Examine the connections for integrity before each use.

Replaceable Parts

Table 8 is a list of replaceable parts for the Product.

Table 8. Replaceable Parts

Item		Fluke Biomedical Part Number
ESA615 Getting Started Manual		4105845
ESA615 Users Manual CD		4105850
Power Cord	USA/Japan	2238680
	UK	2238596
	Australia/China	2238603
	Europe	2238615
	France/Belgium	2238615
	Thailand	2238644
	Israel	2434122
	Switzerland	3379149
	Brazil	3841358
USA to Brazil Outlet Adapter		4151242
Null Post Adapter		3326842
Ansur, CD with demo version		2795488

Table 8. Replaceable Parts (cont.)

Item		Fluke Biomedical Part Number
5-to-5 Banana jack to ECG (BJ2ECG) adapter		3359538
Carrying Case		2248650
Data Transfer Cable		4034393
Fuse	USA-115, Japan ⚠ T20A 250V Fuse (Time Lag), 1¼ in x ¼ in	2183691
	Australia, China, Switzerland ⚠ T10A 250V Fuse (Time Lag), 1¼ in x ¼ in	109298
	Europe, UK, USA-220, France/Belgium, Thailand, Brazil, Israel ⚠ T16A 250V Fuse (Time Lag), 6.3 mm x 32 mm	3321245
15 – 20 A Adapter		2195732
ESA USA/AUS/ISR Accessory Kit: Test Lead Set TP1 Test Probe Set AC285 Alligator Clip Set		3111008
ESA EUR Accessory Kit: Test Lead Set TP74 Test Probe Set AC285 Alligator Clip Set		3111024
⚠ To ensure safety, use exact replacement only.		

Accessories

Table 9 is a list of available accessories for the Product.

Table 9. Accessories

Item	Fluke Biomedical Part Number
Test Leads with Retractable Sheath	1903307
Ground Pin Adapters	2242165
1-to-10 ECG Adapter	3392119
Universal Snap to Banana Adapter	2462072
Ultrasound Test Cable Adapter	3472633
USB Wireless Dongle	3341333

Specifications

Temperature

Operating 10 °C to 40 °C (50 °F to 104 °F)

Storage..... -20 °C to 60 °C (-4 °F to 140 °F)

Humidity 10 % to 90 % non-condensing

Altitude

100 V/115 V ac mains supply voltage 5000 m

230 V ac mains supply voltage 2000 m

Display..... LCD display

Communications

USB Device Upstream Port	Mini-B connector for control by a computer
USB Host Controller Port	Type A, 5 V output, 0.5 A max load. Connector for keyboard and barcode reader
Wireless	IEEE 802.15.4 for control by a computer

Modes of Operation Manual and remote

Power

100 V/115 V power outlet.....	90 to 132 V ac rms, 47 to 63 Hz, 20 A maximum
230 V power outlet.....	180 to 264 V ac rms, 47 to 63 Hz, 16 A maximum

Weight 1.6 kg (3.5 lb)

Size 28.5 cm x 17.6 cm x 8.4 cm (11.2 in x 6.9 in x 3.3 in)

Wireless Radio

Frequency Range	2412 MHz to 2462 MHz
Output Power	<1 mW

Safety

General	IEC 61010-1: Overvoltage Category II, Pollution Degree 2
Measurement	IEC 61010-2-030: CAT II 300 V

IP Rating IEC 60529: IP20

Electromagnetic Compatibility (EMC)

International IEC 61326-1: Basic Electromagnetic Environment CISPR 11: Group 1, Class A

Group 1: Equipment has intentionally generated and/or uses conductively-coupled radio frequency energy that is necessary for the internal function of the equipment itself.

Class A: Equipment is suitable for use in all establishments other than domestic and those directly connected to a low-voltage power supply network that supplies buildings used for domestic purposes. There may be potential difficulties in ensuring electromagnetic compatibility in other environments due to conducted and radiated disturbances.

Emissions that exceed the levels required by CISPR 11 can occur when the equipment is connected to a test object. The equipment may not meet the immunity requirements of this standard when test leads and/or test probes are connected.

Korea (KCC).....Class A Equipment (Industrial Broadcasting & Communication Equipment)

Class A: Equipment meets requirements for industrial electromagnetic wave equipment and the seller or user should take notice of it. This equipment is intended for use in business environments and not to be used in homes.

USA (FCC).....47 CFR 15 subpart B. This product is considered an exempt device per clause 15.103.

Detailed Specifications

Test Standard SelectionsANSI/AAMI ES-1, IEC62353, IEC60601-1, and AN/NZS 3551

Voltage

Ranges (Mains voltage)90.0 V to 132.0 V ac rms
180.0 V to 264.0 V ac rms

Range (Point-to-point voltage)

5000 m0.0 V to ≤ 150 V ac rms

2000 m0.0 V to ≤ 300.0 V ac rms

Accuracy..... $\pm(2\%$ of reading + 0.2 V)

Earth Resistance

Modes.....2-Wire

Test Current>200 mA ac

Range.....0.000 Ω to 2.000 Ω

Accuracy..... $\pm(2\%$ of reading + 0.015 Ω)

Equipment Current

Range.....0.0 A to 20.0 A ac rms

Accuracy..... $\pm(5\%$ of reading + (2 counts or 0.2 A, whichever is greater))

Duty cycle 15 A to 20 A, 5 min on/5 min off
 10 A to 15 A, 7 min on/3 min off
 0 A to 10 A, continuous

Leakage Current

Modes* AC+DC (True-rms)
 AC only
 DC only

* For tests that do not use MAP voltage, AC+DC, AC ONLY, and DC ONLY modes are available for all leakages. MAP voltages are available only in True-rms (shown as AC+DC)

Patient Load Selection AAMI ES1-1993 Fig. 1
 IEC 60601: Fig. 15

Crest factor ≤ 3

Ranges 0.0 μ A to 199.9 μ A
 200 μ A to 1999 μ A
 2.00 mA to 10.00 mA

Accuracy

DC to 1 kHz $\pm(1\%$ of reading + (1 μ A or 1 LSD, whichever is greater))
 1 kHz to 100 kHz $\pm(2\%$ of reading + (1 μ A or 1 LSD, whichever is greater))
 1 kHz to 5 kHz (current > 1.6 mA) $\pm(4\%$ of reading + (1 μ A or 1 LSD, whichever is greater))
 100 kHz to 1 MHz $\pm(5\%$ of reading + (1 μ A or 1 LSD, whichever is greater))

Note

Accuracy for Isolation, MAP, Direct AP, Alternative AP, and Alternative Equipment leakage tests all ranges are:

- *At 120 V ac + (2.5 μ A or 1 LSD, whichever is greater)*
- *At 230 V ac additional $\pm 3.0\%$ and + (2.5 μ A or 1 LSD, whichever is greater)*

For Alternative equipment, Alternative AP, and Direct AP leakage tests, the leakage values are compensated for nominal mains as per 62353. Therefore, the accuracy specified for other leakages is not applicable.

Mains on applied part test voltage 100 % \pm 7 % of Mains for AAMI, current limited to 1 mA \pm 25 % per AAMI
100 % \pm 7 % of Mains for IEC 62353 current limited to 3.5 mA \pm 25 % per IEC 62353
100 % \pm 7 % of Mains for IEC 60601-1 current limited to 7.5 mA \pm 25 % per IEC 60601-1

Differential leakage

Ranges 75 μ A to 199 μ A
200 μ A to 1999 μ A
2.00 mA to 20.00 mA
Accuracy \pm (10 % of reading + (2 counts or 20 μ A, whichever is greater))

Insulation resistance

Ranges 0.5 to 20.0 M Ω
20.0 to 100.0 M Ω
Accuracy
20 M Ω Range \pm (2 % of reading + 0.2 M Ω)
100 M Ω Range \pm (7.5 % of reading + 0.2 M Ω)
Source test voltage 500 or 250 V dc (+20 %, -0 %) 2.0 \pm 0.25 mA short-circuit current
Maximum load capacitance 1 μ F

ECG Performance Waveforms

Accuracy
Frequency \pm 2 %
Amplitude \pm 5 % of 2 Hz square wave only, fixed @ 1 mV Lead II configuration
Waveforms
ECG Complex 30, 60, 120, 180, and 240 BPM
Ventricular Fibrillation
Square wave (50 % duty cycle) 0.125 Hz and 2 Hz

Sine wave	10, 40, 50, 60, and 100 Hz
Triangle wave.....	2 Hz
Pulse (63 ms pulse width).....	30 BPM and 60 BPM

Factory-Supplied Test Sequences

- 60601 3rd Edition Patient Monitor
- 60601 3rd Edition Defibrillator
- 60601 3rd Edition Infusion Pump
- 60601 3rd Edition Ultrasound Device
- 60601 3rd Edition Generic Device
- 60601 3rd Edition System
- 62353-Alt. Patient Monitor
- 62353-Alt. Defibrillator
- 62353-Alt. Infusion Pump
- 62353-Alt. Ultrasound Device
- 62353-Alt Generic Device
- NFPA99 Patient Monitor
- NFPA99 Defibrillator
- NFPA99 Infusion Pump
- NFPA99 Ultrasound Device
- NFPA99 Generic Device
- ANSI/AAMI ES-1 Patient Monitor
- ANSI/AAMI ES-1 Defibrillator
- ANSI/AAMI ES-1 Infusion Pump
- ANSI/AAMI ES-1 Ultrasound Device
- ANSI/AAMI ES-1 Generic Device